

Üveg Világ Kft. Orosháza<sup>®</sup>

“Üveg és a körülötte lévő világ”

**4. Termékkatalógus**

# Tartalomjegyzék

<b>Portál szerelvények</b>	<b>4</b>
<b>Fallabda szerelvények</b>	<b>9</b>
<b>Üvegfogadó profilok</b>	<b>12</b>
<b>Beltéri ajtó szerelvények</b>	<b>13</b>
<b>Zuhanykabin szerelvények</b>	<b>19</b>
<b>Üvegbútor szerelvények, polcok</b>	<b>23</b>
<b>Pontmegfogó és előtető szerelvények</b>	<b>29</b>
<b>Tolóajtó szerelvények</b>	<b>31</b>
<b>Korlát szerelvények</b>	<b>32</b>
<b>Balkon-Világ lapozható üvegfalrendszer</b>	<b>34</b>
<b>Balkon-Világ plusz eltolható üvegfalrendszer</b>	<b>35</b>
<b>Kapcsolatok</b>	<b>36</b>

## Zuhanyajtó szerelvények, 6-8-10 mm vastag ESG üvegekhez

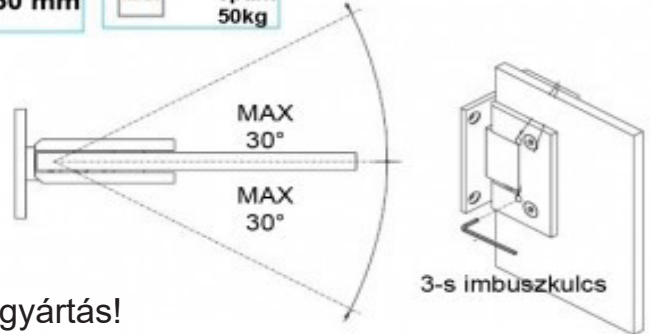

Egyedi méretű üvegyártás!

A hármas imbuszkulccsal meglazítjuk a csavarokat (egy teljes kört mind a kettőnél) beállítjuk az ajtólapot, majd rögzítjük mind a két csavart.

## Beltéri ajtó szerelvények, 8-10 mm vastag ESG üvegekhez, egyedi méretezéssel

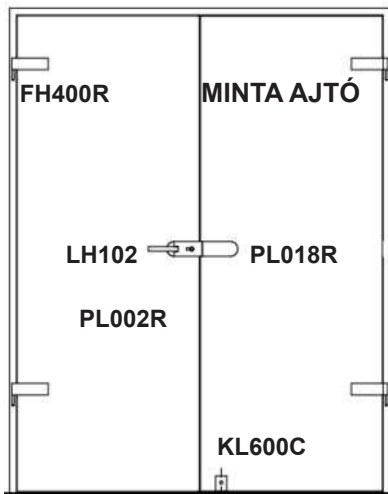

DIN szabvány szerint

Típus	709 mm	834 mm	959 mm
Beépíthető nyílás mérete	750 x 2000 (750 x 2125)	875 x 2000 (875 x 2125)	1000 x 2000 (1000 x 2125)
Üvegajtó mérete	709 x 1972 (709 x 2097)	834 x 1972 (834 x 2097)	959 x 1972 (959 x 2097)
Falc mérete	716 x 1983 (716 x 2108)	841 x 1983 (841 x 2108)	966 x 1983 (966 x 2108)

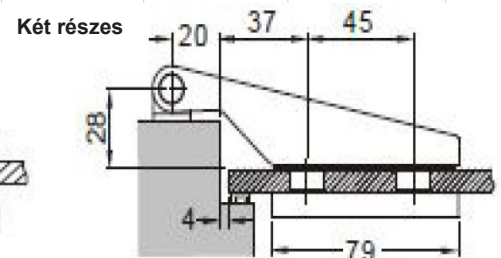
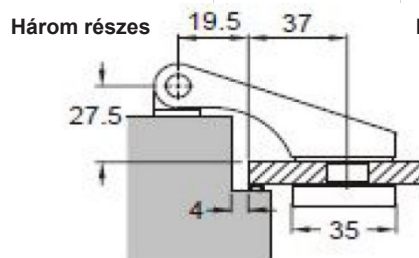

## Portálajtó szerelvények, 8-10-12 mm vastag ESG üvegekhez

Ajtóforgásponthoz merevítő borda javasolt 3200 mm magasság felett

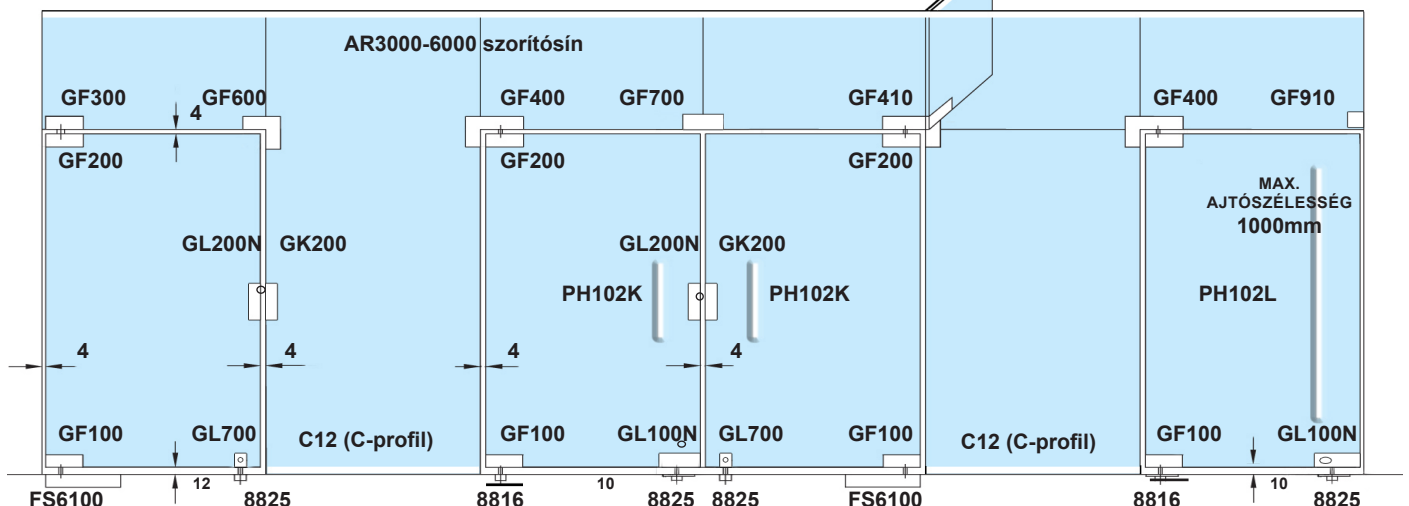

## AJTÓ FORGÁSPONTOK ÉS ELLENDARABOK

**GF100 Ajtó alsóforgáspont, szálcsiszolt, eloxált alumínium**

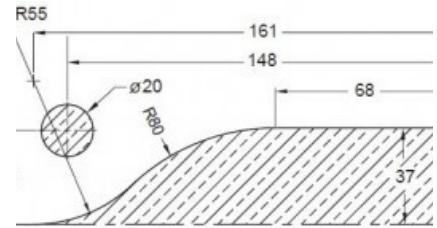
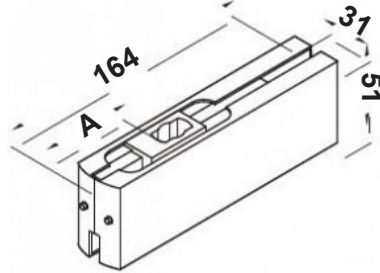
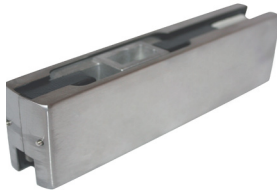

**GF200 Ajtó felsőforgáspont, szálcsiszolt, eloxált alumínium**

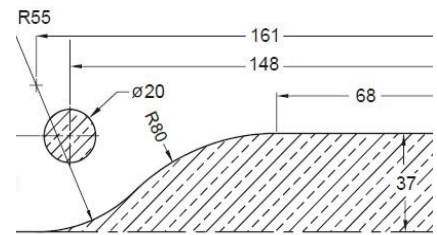
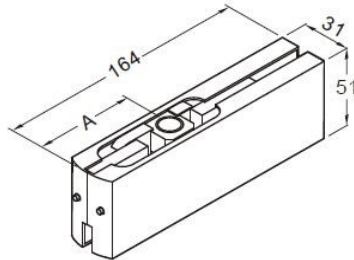

**GF300 Ajtó felsőforgáspont ellendarab, felüvilágító rögzítéssel, szálcsiszolt, eloxált alumínium**

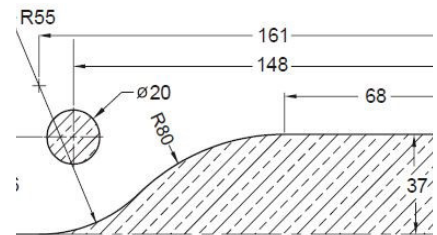
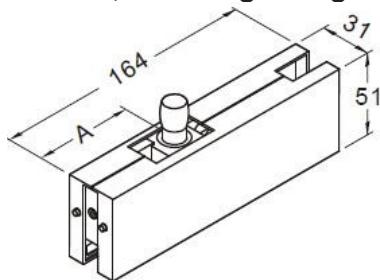

**GF400 Ajtó felsőforgáspont ellendarab, oldal- és felüvilágító rögzítéssel, szálcsiszolt, eloxált alumínium**

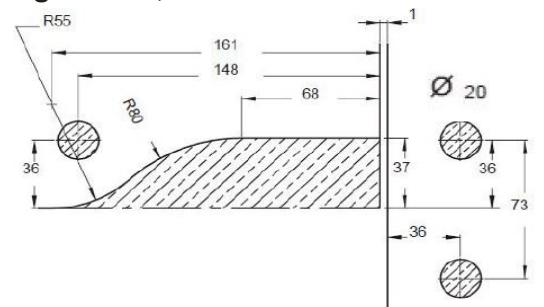
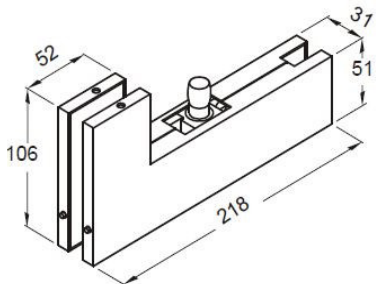

**GF410L Ajtó felsőforgáspont ellendarab, jobbos / balos, oldal-, felüvilágító- és bordarögzítéssel, szálcsiszolt, eloxált alumínium**



**GF410R**

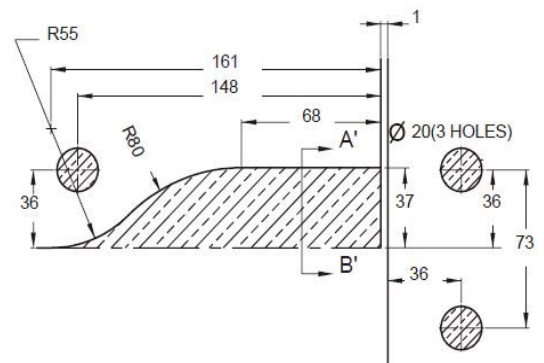
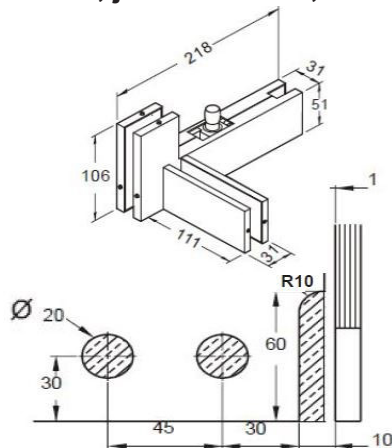

## AJTÓ FORGÁSPONTOK ÉS ELLENDARABOK

**GF420L** Ajtó felsőforgáspont ellendarab, jobbos / balos, 90°-os, oldal- és felülvilágító rögzítéssel, szálcsiszolt, eloxált alumínium



GF420R

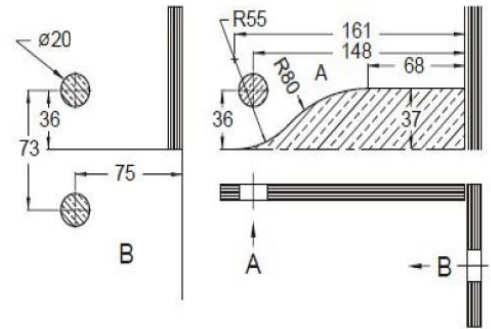
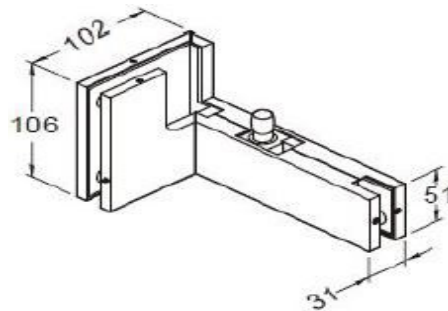

**GF430L** Ajtó felsőforgáspont ellendarab, jobbos / balos, 135°-os oldal- és felülvilágító rögzítéssel, szálcsiszolt, eloxált alumínium



GF430R

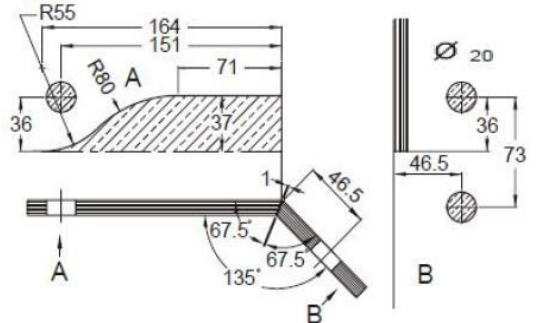
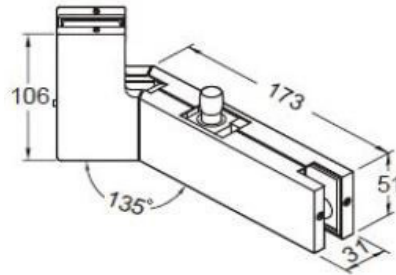

**GF600** Hármás megfogó, oldal- és felülvilágító rögzítéssel, szálcsiszolt, eloxált alumínium



GF601

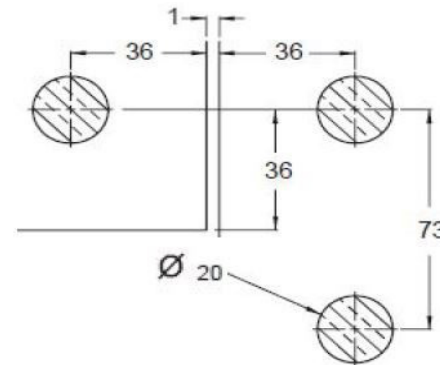
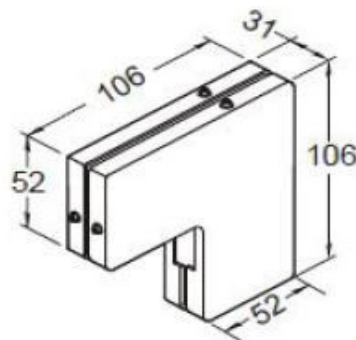

**GF700** Kettes megfogó, ajtó ütközővel, szálcsiszolt, eloxált alumínium



GF701

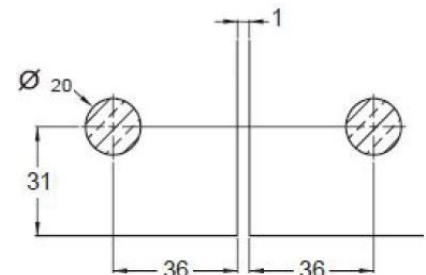
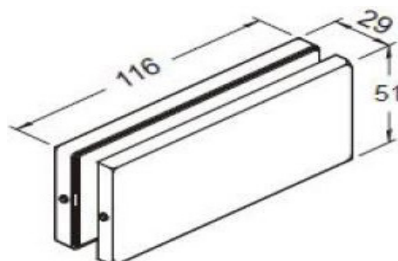

## AJTÓ FORGÁSPONTOK, ELLENDARABOK, FIXMEGFOGÓK

**GF710** Kettes megfogó bordarögzítéssel, szálcsiszolt, eloxált alumínium

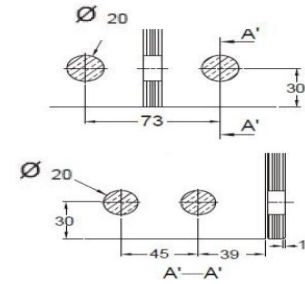
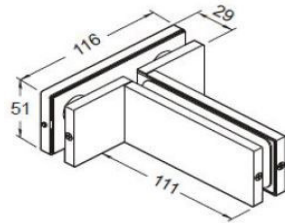

**GF800** Négyes megfogó, szálcsiszolt, eloxált alumínium

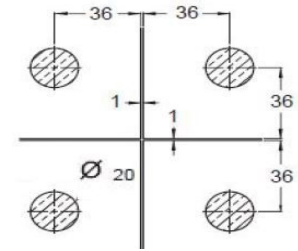
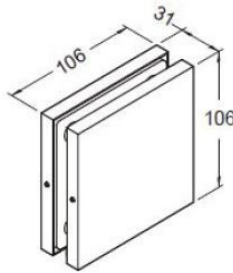

**GF810** Négyes megfogó, bordarögzítéssel, szálcsiszolt, eloxált alumínium

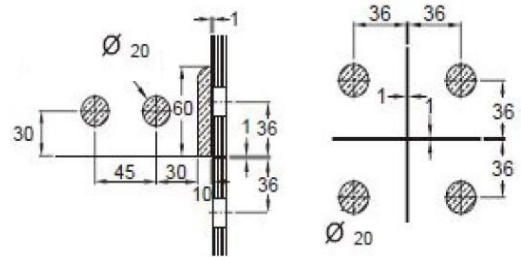
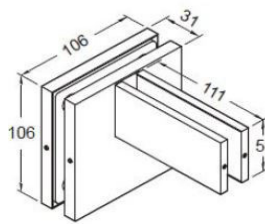

**GF910** Egyes megfogó, ütközővel, szálcsiszolt

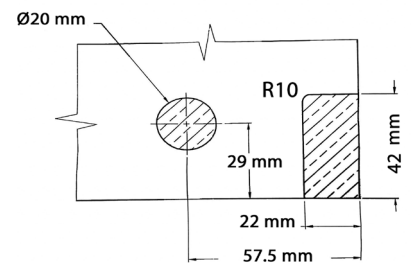
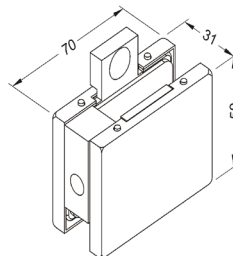

**GL100N** Sarokzár, szálcsiszolt, eloxált alumínium

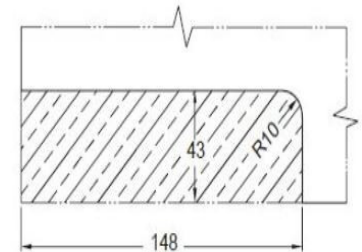
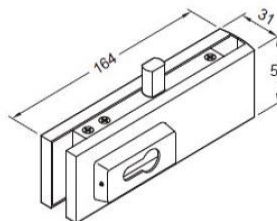

**GL200N** Középzár, szálcsiszolt, eloxált alumínium

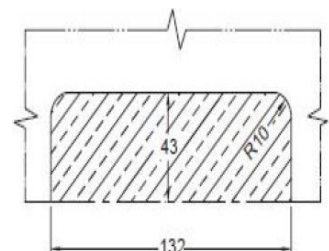
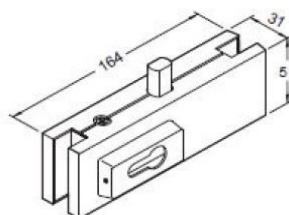
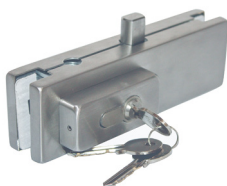

## ZÁR ÉS ELLENDARAB

**GL700N Álló alsó zár, szálcsiszolt, eloxált alumínium**

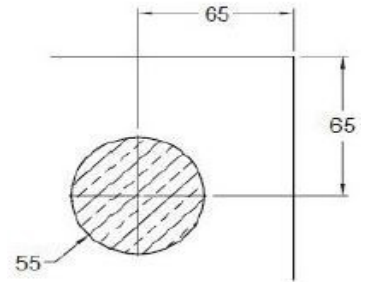
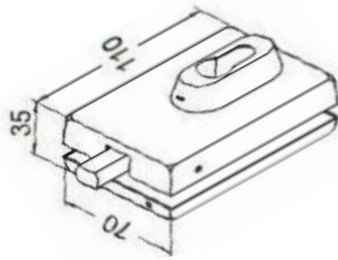
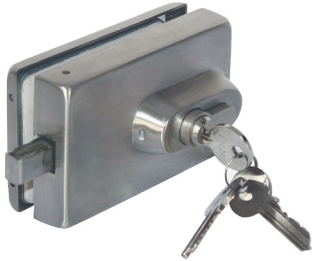

**GK200 Középszár ellendarab, szálcsiszolt, eloxált alumínium**

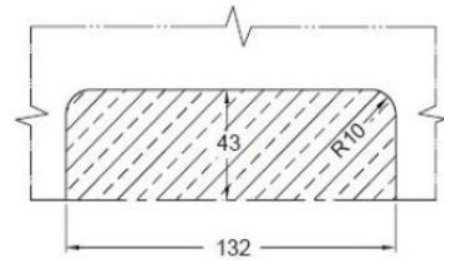
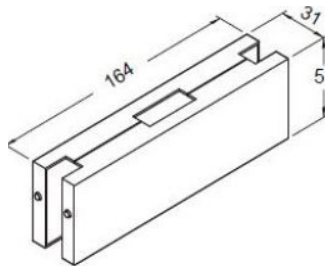

**AR6000-3000 Fali csatlakozó sín, 6 és 3 m-ben**

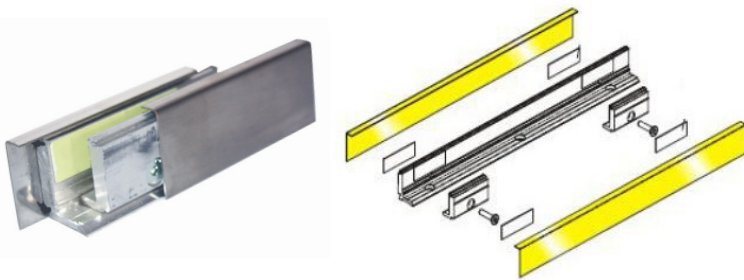

Rozsdamentes színre eloxált alumínium vagy eloxált alumínium kivitelben (pattintós rögzítéssel)

Rozsdamentes szálcsiszolt vagy polírozott kivitelben (ragasztott rögzítéssel)

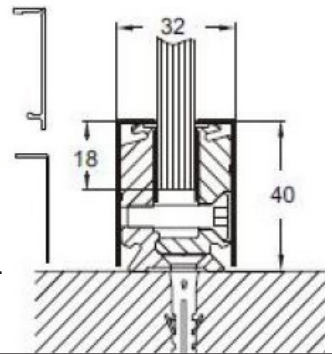

## PORTÁL KIEGÉSZÍTŐ SZERELVÉNYEK

**8815 Ajtó felső forgáspont ellendarab, szálcsiszolt**

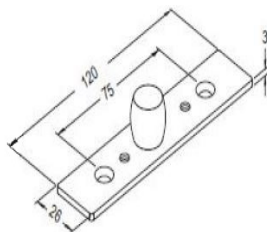

**8816 Ajtó alsó forgáspont ellendarab (74-75AX), szálcsiszolt**

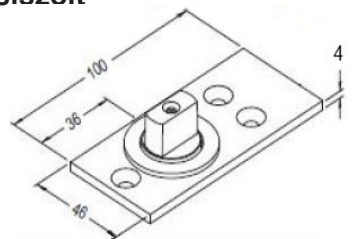

**8820 Ajtó felső forgáspont ellendarab, felülvilágító rögzítéssel, falhoz való csatlakozás, szálcsiszolt**

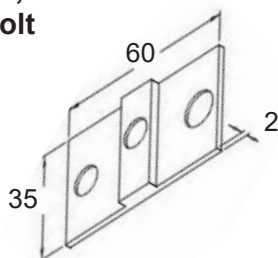

**8825 Sarokzár ellendarab, zárhüvely, szálcsiszolt**

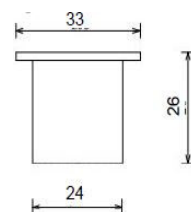
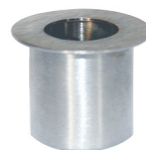

## HIDRAULIKUS AJTÓPÁNTOK

### HH1000S Hidraulikus ajtópánt, szálcsiszolt



- Üvegvastagság: 8-10mm  
Két hidraulikus pánt alkalmazásakor:
- Max szélesség: 1000 mm
  - Max magasság: 2800 mm
  - Max teherbírás: 80 kg

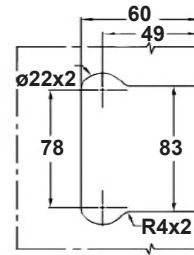

### HH1000S-T Hidraulika nélküli ajtópánt, szálcsiszolt



- Egy hidraulikus pánt alkalmazásakor:
- Max szélesség: 900 mm
  - Max magasság: 2400 mm
  - Max teherbírás: 60 kg

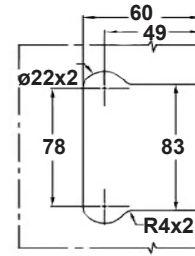

### HF1100S Hidraulikus alsó forgáspont, szálcsiszolt

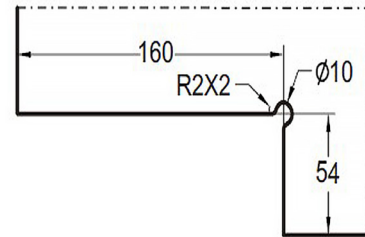
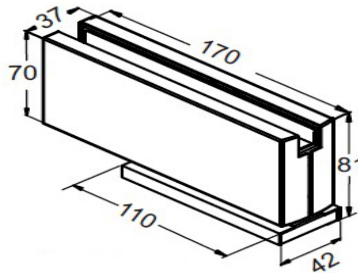

### HF2000S Hidraulikus felső forgáspont, szálcsiszolt

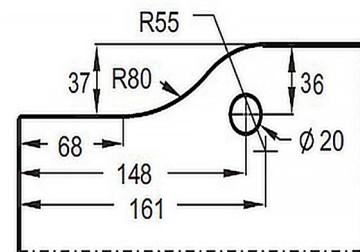
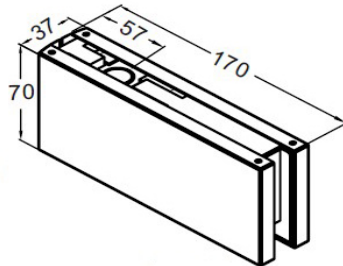

### AH500S Alsó-felső forgáspontos, rugós pánt, szálcsiszolt, polír (60kg) 8-10 mm-es üveghez

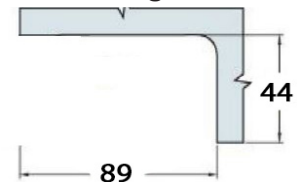
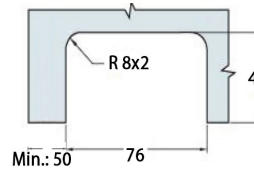
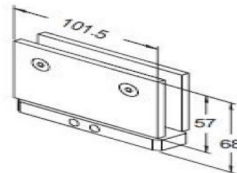

### AH503S Forgáspontos rugós pánt, felülvilágító rögzítéssel, szálcsiszolt (60kg) 8-10 mm-es üveghez

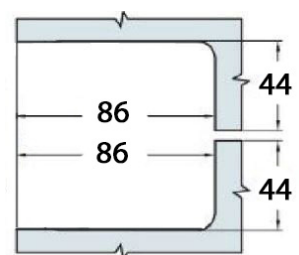
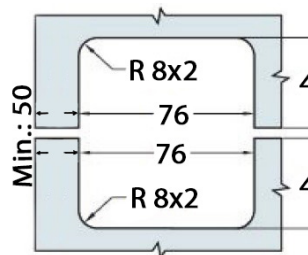
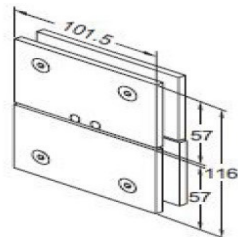



## FS6100 HIDRAULIKUS PADLÓCSUKÓ, SZÁLCSISZOLT



Nyitási erő	Záró erő	Max. ajtó szélesség
Nagyon könnyű	15 N.m	Max. 900mm
Könnyű	20 N.m	Max. 900mm
Közepesen nehéz	25 N.m	Max. 1000mm
Nehéz	33 N.m	Max. 1000mm

- maximum ajtó nyitási szög 130 fok
- mechanikus rögzítés 0 fok, 90 fok, illetve 105 fok
- 5 és 10 mm magas cserélhető csap
- ajtólap csukási és zárási sebességének állítása
- doboz mérete: 108mmx307mmx40mm
- üveg súlya maximum 100kg lehet

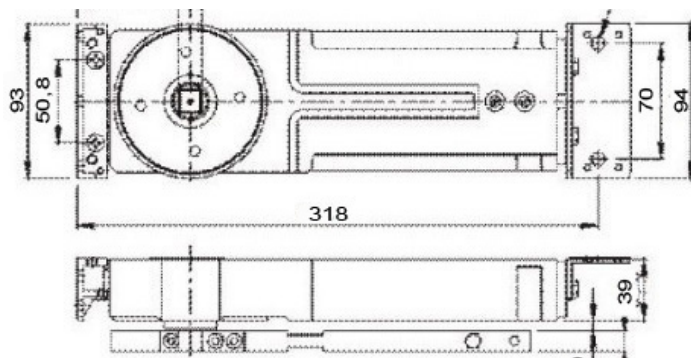
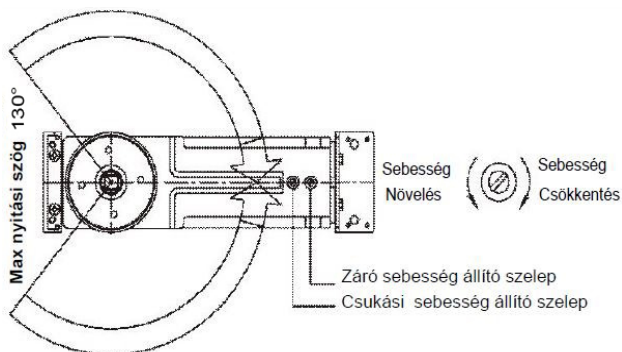

## FALLABDA SZERELVÉNYEK



### Zárak és zárellendarab

Külső oldali Zár



Belső oldali zár



Zár ellendarab



Borda rögzítők



Pántok



Fallabda pálya szerelvények verseny- és gyakorló pályákhoz egyaránt, porszórt kivitelben.

# PORTÁL SZERELVÉNYEK

## JELZŐZÁRAK, RÁHÚZHATÓ ZÁRAK

**KL600C Ráhúzható kulcsos zár, szálcsiszolt**

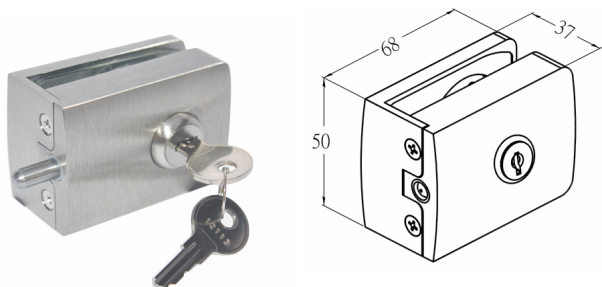

**IL602C Ráhúzható zár ellendarab, szálcsiszolt**

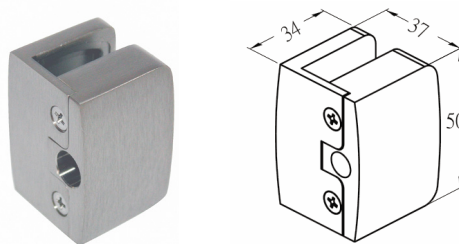

**IL600C Ráhúzható, kijelzős zár forgatógombos, szálcsiszolt**

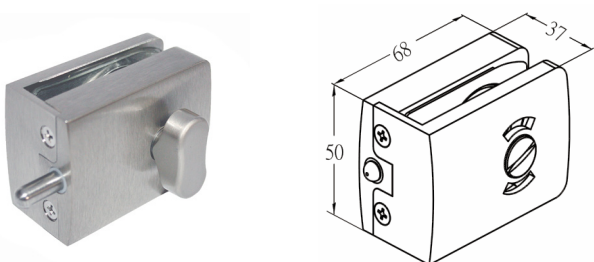

**IL601C Ráhúzható zár ellendarab, szálcsiszolt**

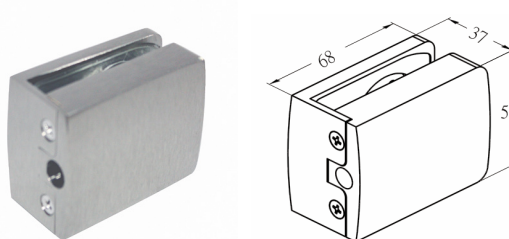

**GL601C Ráhúzható, forgatógombos zár és zár ellendarab, szálcsiszolt**

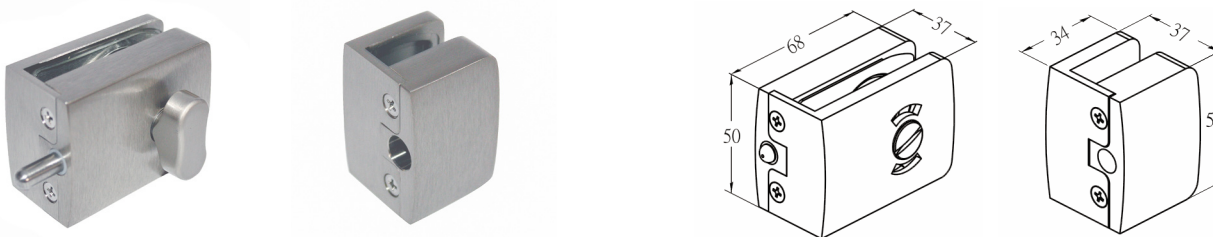

**IL702C Zár ellendarab, szálcsiszolt, polír**

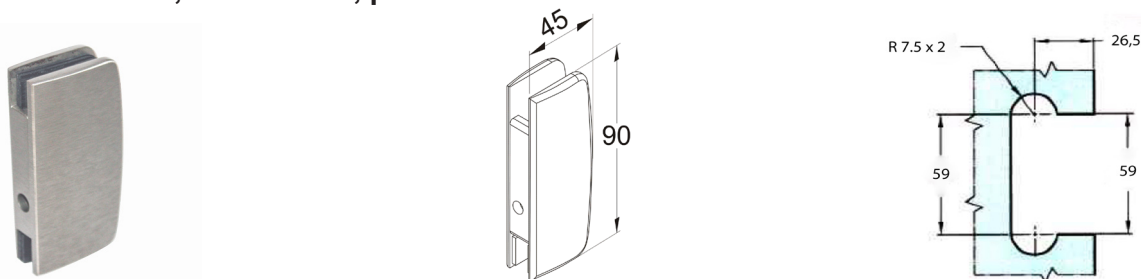

**ILH700C Kijelzős zár, forgatógombos, szálcsiszolt, polír**

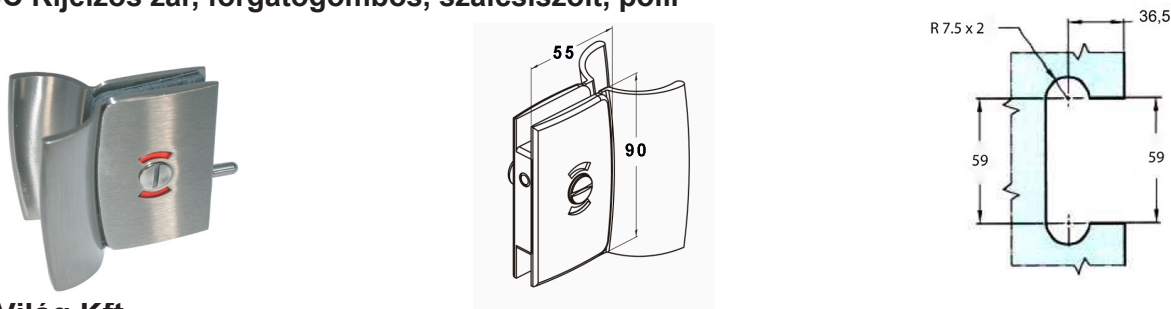

## TOLÓPAJZSOK

### PH100 Szálcsiszolt

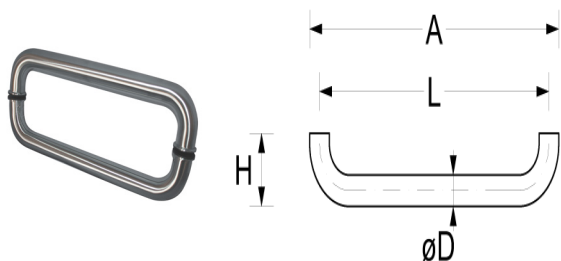

	A	D	L	H
Cikkszám	Teljes Méret	Átmérő	Furattáv	Kiállás
PH100	382mm	Ø32mm	350mm	55mm

### PH102 Szálcsiszolt

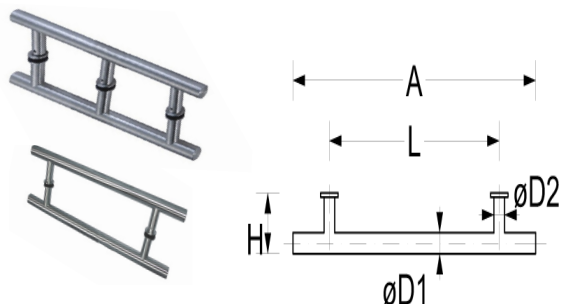

	A	D1	D2	L	H
Cikkszám	Teljes méret	ØD1	ØD2	Furattáv	Kiállás
PH102C	1200mm	Ø32	Ø25	1000mm	65mm
PH102K	500mm	Ø26	Ø22	350mm	60mm
PH102L	1760mm	Ø32	Ø25	680X2	65mm

### PH103C Szálcsiszolt

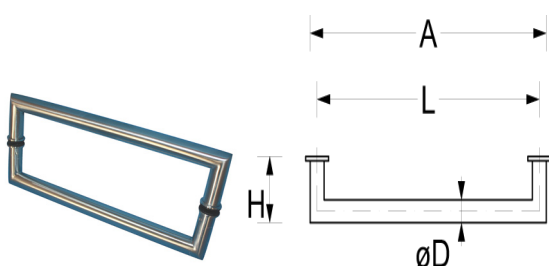

	A	D	L	H
Cikkszám	Teljes méret	Átmérő	Furattáv	Kiállás
PH103C	375mm	Ø25mm	350mm	57,5mm

### PH117 Szálcsiszolt, polír

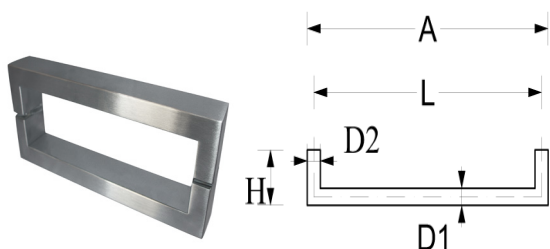

	A	D	L	H
Cikkszám	Teljes méret	Átmérő	Furattáv	Kiállás
PH117	325mm	20/40mm	305mm	53/70mm
PH117B	270mm	20/40mm	250mm	53mm

### PH200 Szálcsiszolt, polír

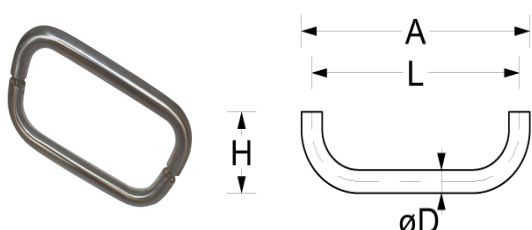

	A	D	L	H
Cikkszám	Teljes méret	Átmérő	Furattáv	Kiállás
PH200	220mm	20mm	200mm	60mm

## „U”, „C”, „L” PROFILOK

### Üvegfogadó profilok

Különböző raktári „U” „C” valamint „L”, illetve egyedi gyártású lemez profilok, külmérettel. Rozsdamentes szálcsiszolt, polír, RAL festett kivitelben, kérésre fekete gumitömítéssel.

#### C12 profil

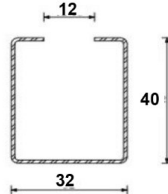
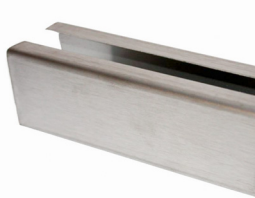

32x40mm	10mm-es üveghez	H-3000mm	Lv. 1
---------	-----------------	----------	-------

#### C16 profil

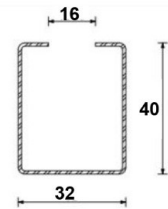
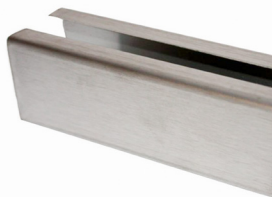

10 mm-es üveghez beverő-, ékelő gumival ajánlott!

32x40mm	10mm-es üveghez	H-3000mm	Lv. 1
---------	-----------------	----------	-------

#### L profil szorító sínfedél

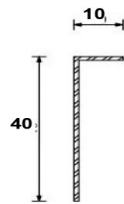
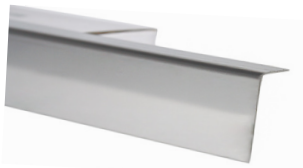

10 x 40 mm	H-3000mm	Lv. 1
------------	----------	-------

#### U12 profil

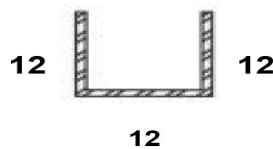

12x12x12mm	H-3000mm	Lv. 1
------------	----------	-------

#### U15 profil

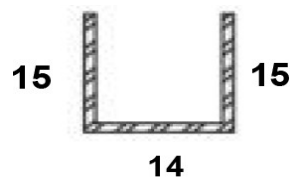

15x14x15mm	H-3000mm	Lv. 1
------------	----------	-------

#### U20 profil

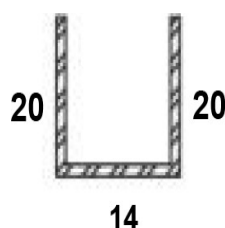

20x14x20mm	H-3000mm	Lv. 1
------------	----------	-------

## BELTÉRI AJTÓZÁRAK

PL002G Beltéri ajtózárral, cylinderbetétes, szálcsiszolt, eloxált alumínium

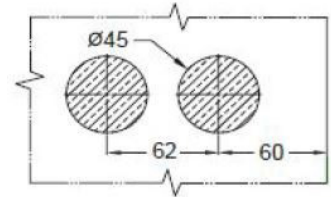
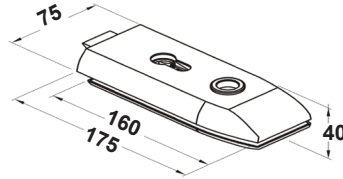

PL006G Beltéri ajtózárral, csak kilincses, szálcsiszolt, eloxált alumínium

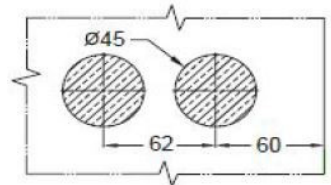
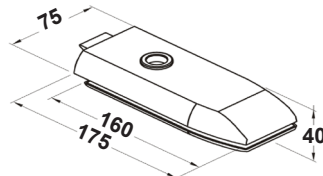

PL002R Beltéri ajtózárral, cylinderbetétes, szálcsiszolt

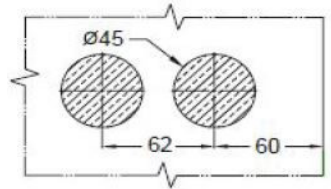
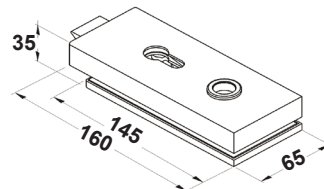

PL002S Beltéri ajtózárral, cylinderbetétes, szálcsiszolt, polír, eloxált alumínium

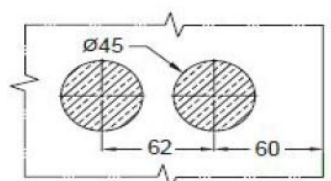
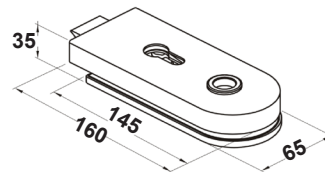

PL006S Beltéri ajtózárral, csak kilincses, szálcsiszolt, polír, eloxált alumínium

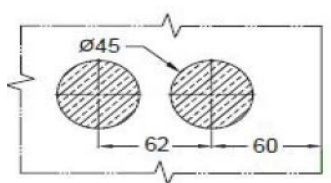
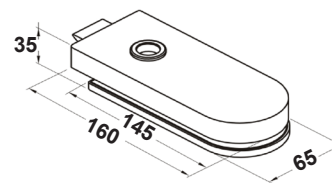

PL012G Beltéri ajtózárral, cylinderbetétes, szálcsiszolt

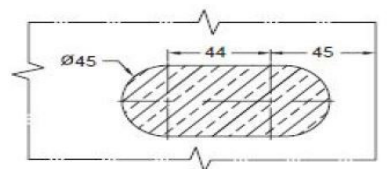
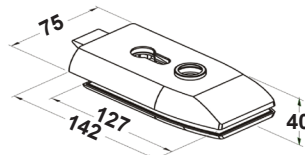

WLI012G Beltéri kijelzős ajtózárral, forgatógombos, cylinderbetétes, szálcsiszolt

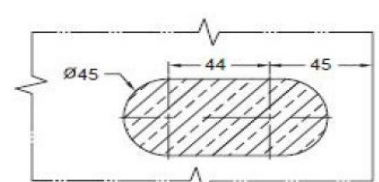
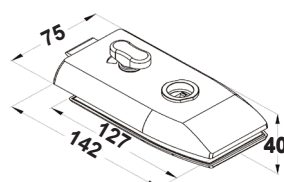

## BELTÉRI AJTÓZÁR ELLENDARABOK

PL008S Beltéri ajtózárral ellendár, eloxált alumínium

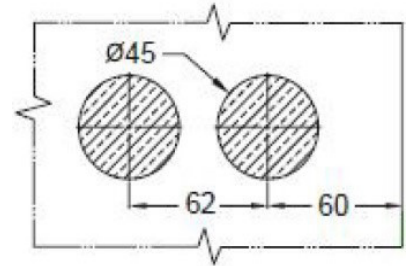
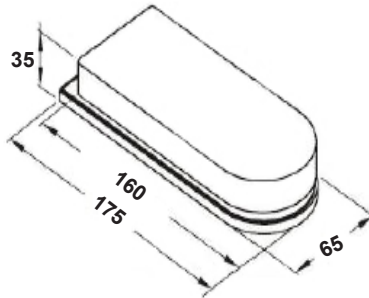

PL008G Beltéri ajtózárral ellendár, szálcsiszolt

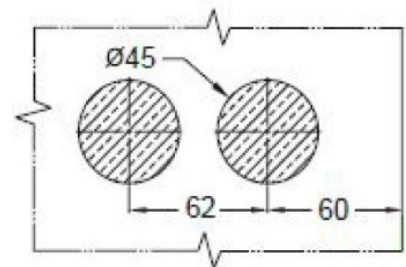
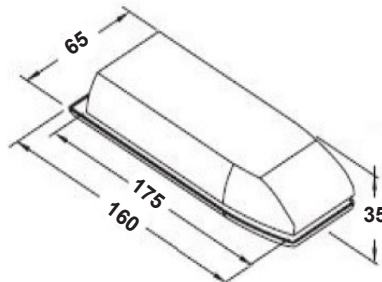
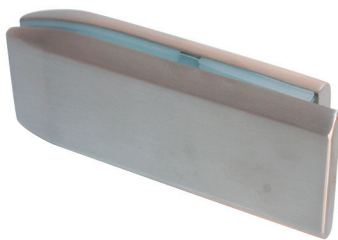

PL018S Beltéri ajtózárral ellendár rövid, szálcsiszolt

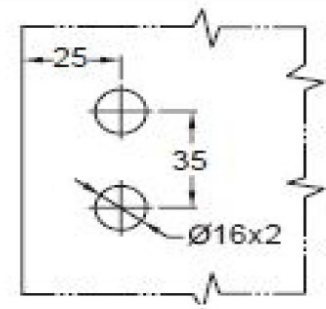
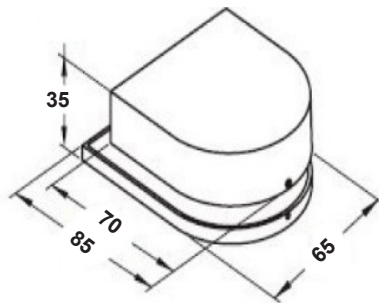

PL018G Beltéri ajtózárral ellendár rövid, szálcsiszolt

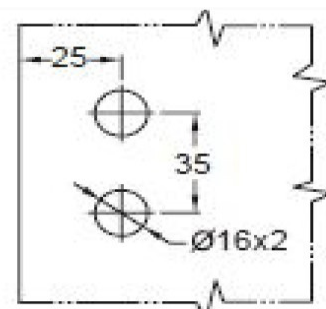
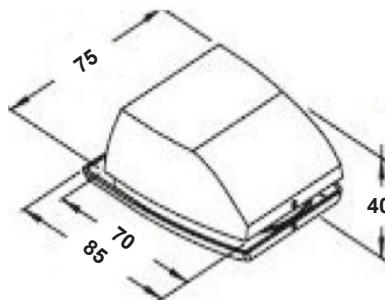

PL018R Beltéri ajtózárral ellendár rövid, szálcsiszolt

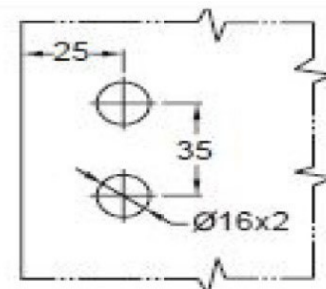
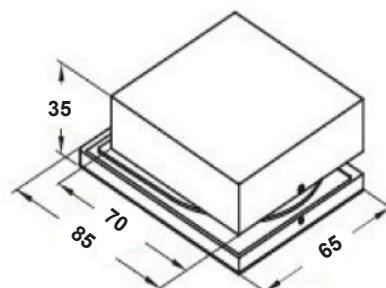

## BELTÉRI AJTÓ KIEGÉSZÍTŐ SZERELVÉNYEK

KP03 Tokra szerelhető zárlemez, szálcsiszolt

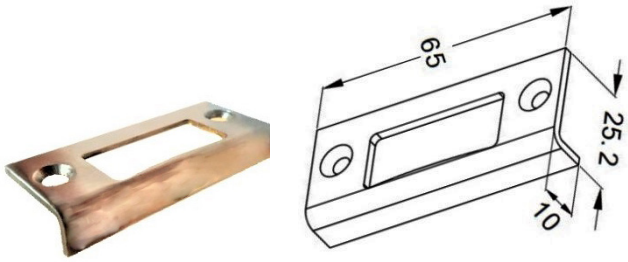

PL07C Falra szerelhető ütközős zárlemez, szálcsiszolt

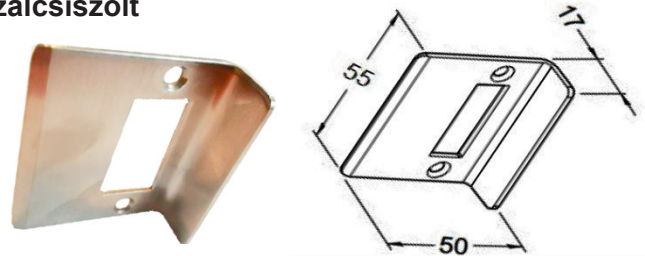

DC02 30/30 zárbetét 3 kulcsos

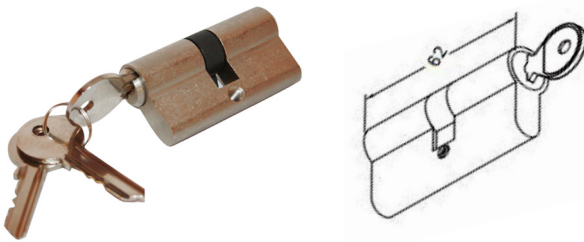

TC02 30/30 Forgatógombos zárbetét, 3 kulcsos

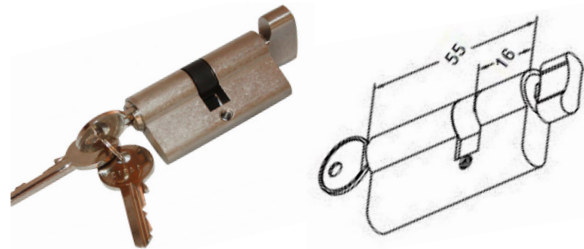

4002 Tokra szerelhető ajtócsap, acél

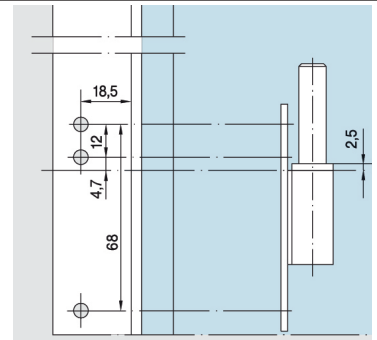
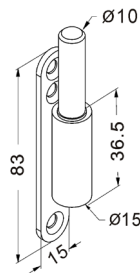

4006 Ajtócsap, tokra szerelhető háromrészes pánthoz, kérhető DIN tokhoz is (FH410C), acél

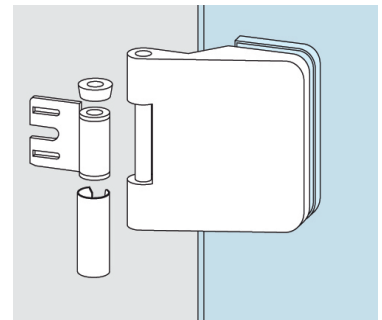
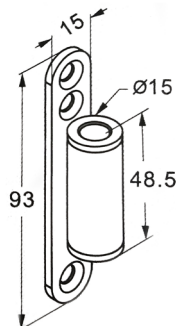

DIN csap, ajtó tokba, acél

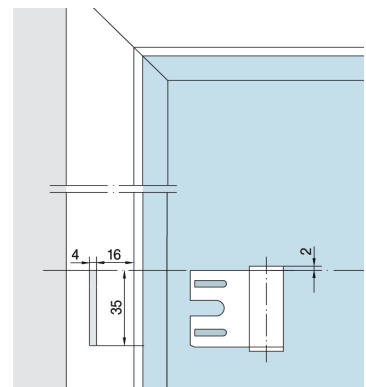
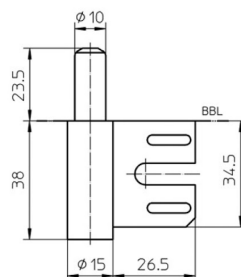

## KILINCSEK

LH102, polír, szálcsiszolt, eloxált alumínium

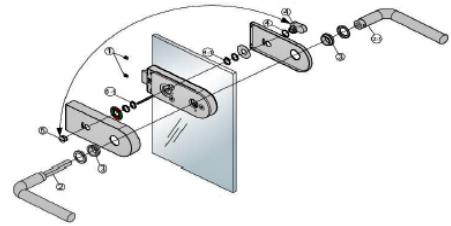
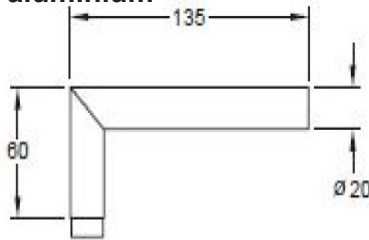

LH105, eloxált alumínium

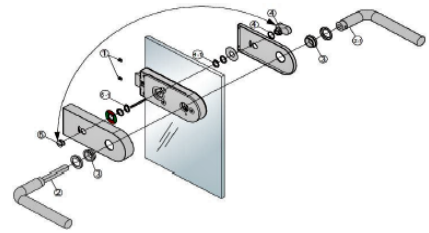
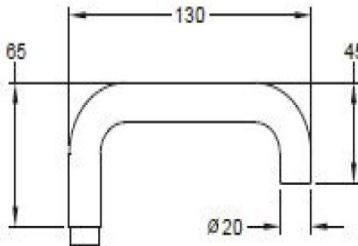

LH106, szálcsiszolt

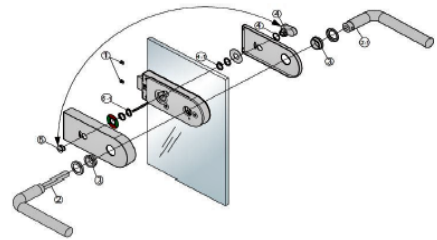
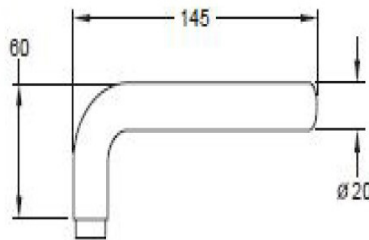

LH107, szálcsiszolt

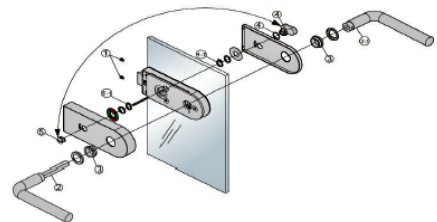
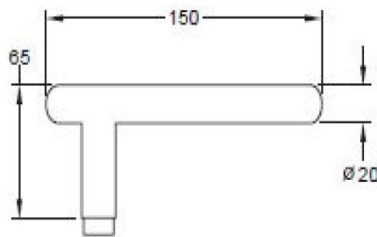

LH112, szálcsiszolt

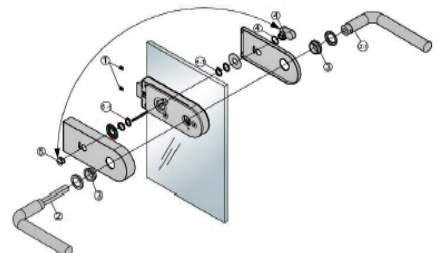
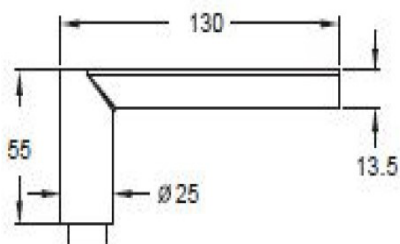
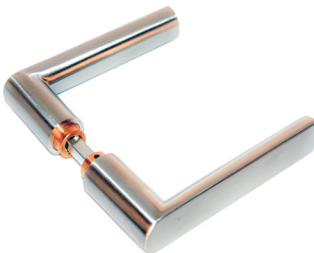



## FELNYÍLÓ AJTÓPÁNTOK

**FH101G Felnyíló ajtópánt, szálcsiszolt, polír (36kg / 2pánt)**

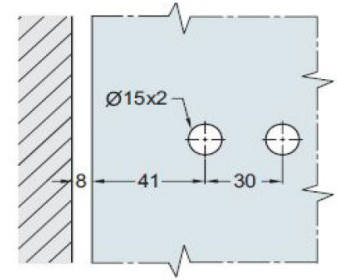
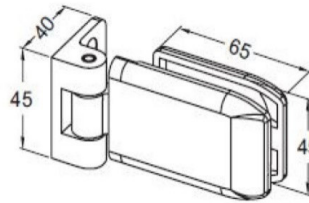

**FH102G Felnyíló ajtópánt, szálcsiszolt, polír (36kg / 2pánt)**

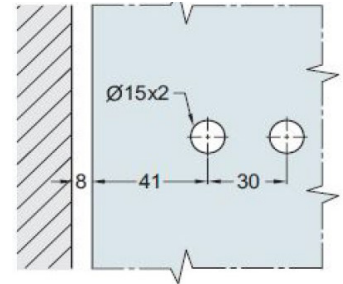
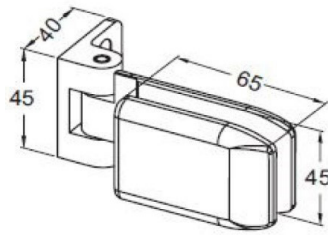

**FH103G Felnyíló ajtópánt, szálcsiszolt, polír (36kg / 2pánt)**

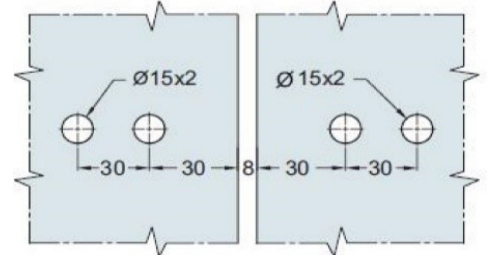
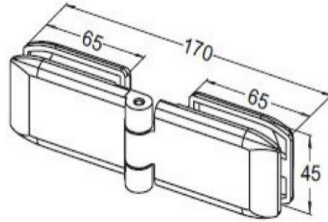

**FH400C Felnyíló ajtópánt, csak eloxált alumínium (40kg / 2 pánt)**

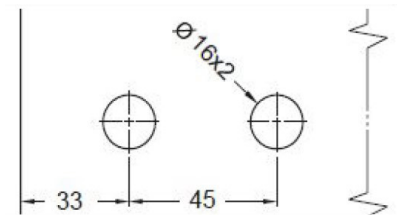
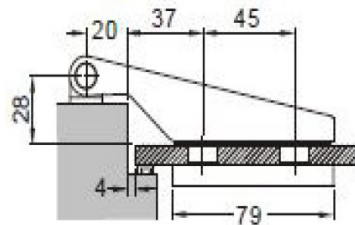
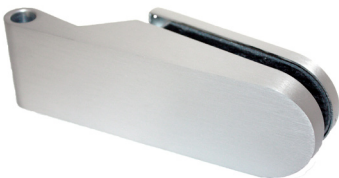

**FH400N Felnyíló ajtópánt, szálcsiszolt, polírozott (40kg / 2 pánt)**

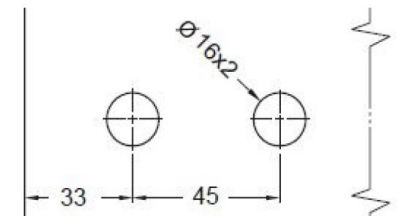
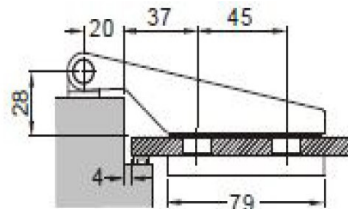

**FH400G Felnyíló ajtópánt, szálcsiszolt (40kg / 2 pánt)**

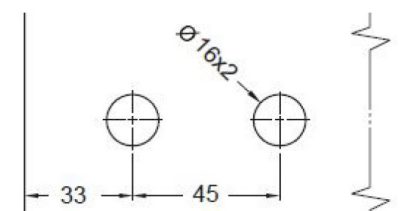
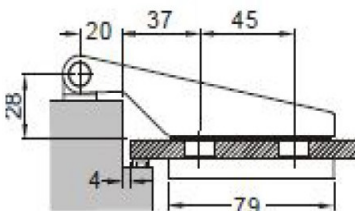

## FELNYÍLÓ AJTÓPÁNTOK

**FH400R Felnyíló ajtópánt, szálcsiszolt (40kg / 2 pánt)**

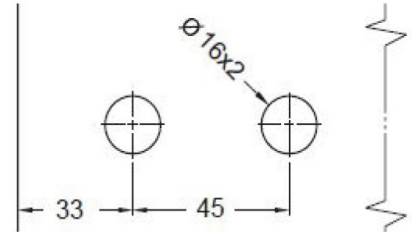
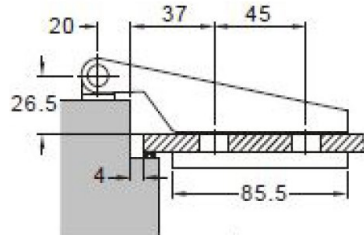

**FH401G Tokba való, talpas felnyíló ajtópánt, szálcsiszolt (45kg / 2 pánt)**

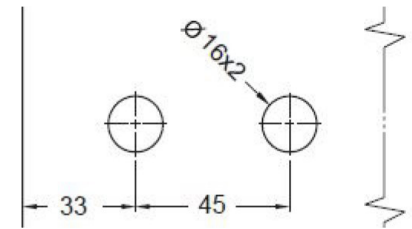
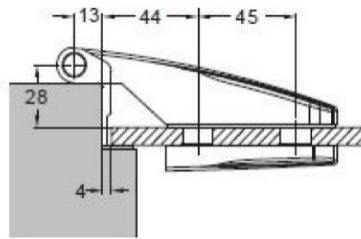
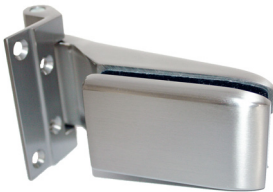

**FH410C Háromrészes, felnyíló ajtópánt, szálcsiszolt (45kg / 2 pánt)**

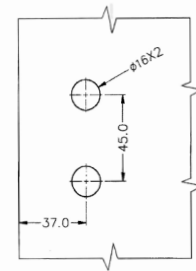
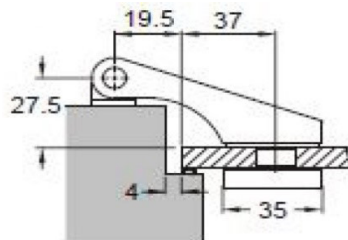

**FH411C Tokba való, talpas felnyíló ajtópánt, szálcsiszolt (45kg / 2 pánt)**

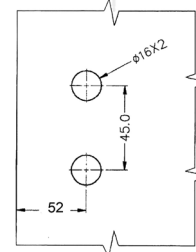
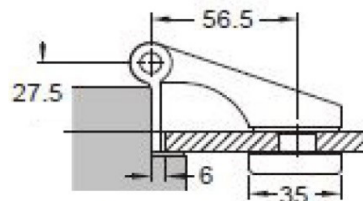

**FH801R Dupla furatos szaunapánt, szálcsiszolt, polír (28kg / 2 pánt)**

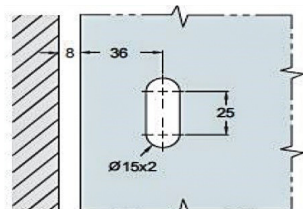
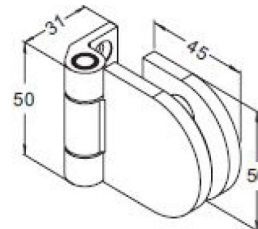

**FH803R Dupla furatos üveg-üveg szaunapánt, szálcsiszolt, polír (28kg / 2 pánt)**

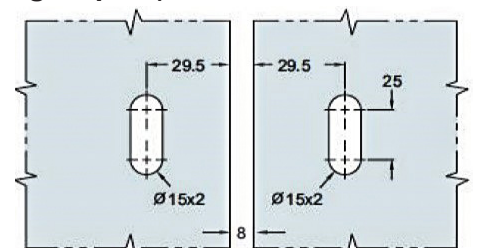
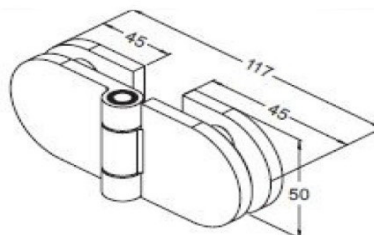

## ZUHANYPÁNTOK, FORGÁSPONTOK

**AH400C** Állítható aszimmetrikus rugós pánt, szálcsiszolt, polír (28kg/2pánt) 6-8 mm-es üveghez

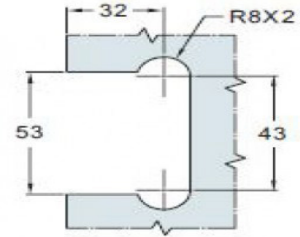
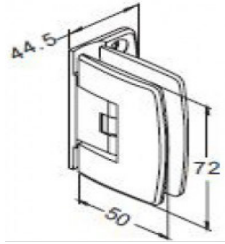

**AH401C** Állítható szimmetrikus rugós pánt, szálcsiszolt, polír (28kg/2pánt) 6-8 mm-es üveghez

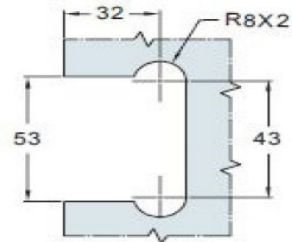
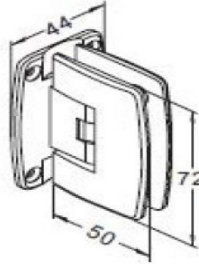

**AH403C** 180° Állítható üveg-üveg rugós pánt, szálcsiszolt, polír (28kg/2pánt) 6-8 mm-es üveghez

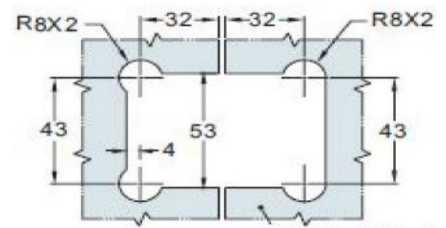
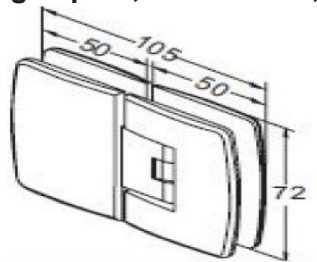

**AH404C** 90° Állítható üveg-üveg rugós pánt, szálcsiszolt, polír (28kg/2pánt) 6-8 mm-es üveghez

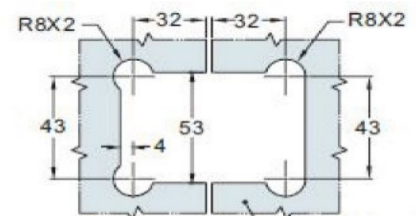
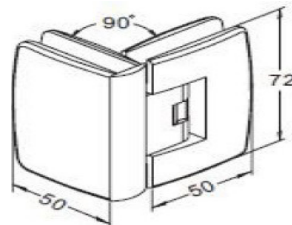

**AH500S** Alsó-felső forgáspontos, rugós pánt, szálcsiszolt, polír (60kg) 8-10 mm-es üveghez

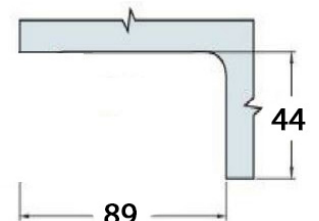
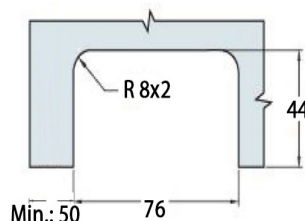
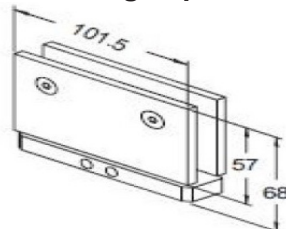

**AH503S** Forgáspontos rugós pánt, felülvilágító rögzítéssel, szálcsiszolt (60kg) 8-10 mm-es üveghez

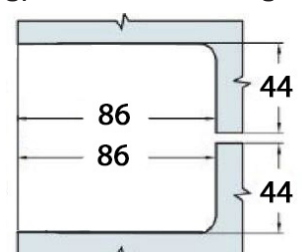
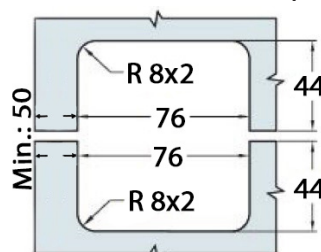
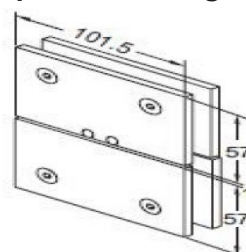

## ZUHANYPÁNTOK

**AH600G Aszimmetrikus, állítható rugós pánt, szálcsiszolt, polír (43kg/2pánt) 8-10 mm-es üveghez**

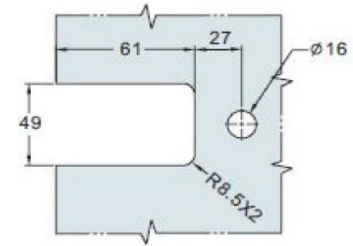
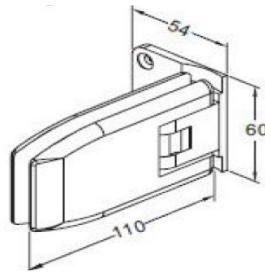

**AH601G Szimmetrikus, állítható rugós pánt, szálcsiszolt, polír (43kg/2pánt) 8-10 mm-es üveghez**

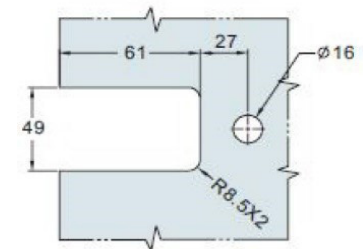
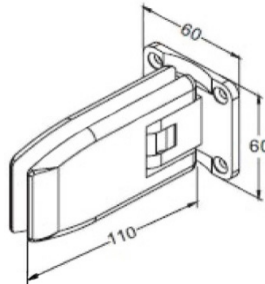

**AH603G 180° Üveg-üveg, állítható rugós pánt, szálcsiszolt, polír (43kg/2pánt) 8-10 mm-es üveghez**

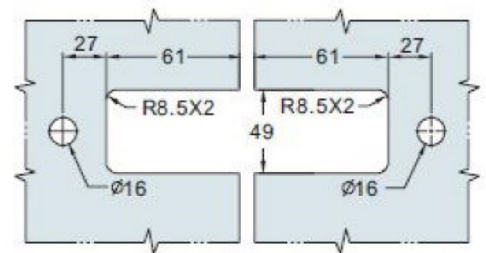
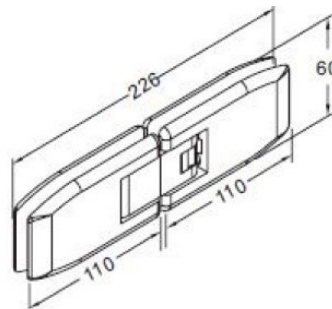

**AH700G Aszimmetrikus, állítható rugós pánt, szálcsiszolt, polír (36kg/2pánt) 8-10 mm-es üveghez**

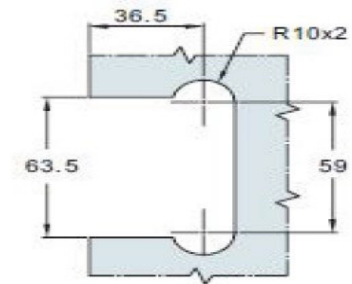
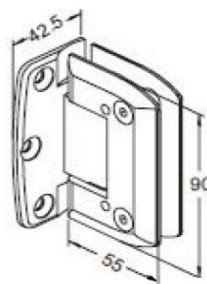

**AH701G Szimmetrikus, állítható rugós pánt, szálcsiszolt, polír (36kg/2pánt) 8-10 mm-es üveghez**

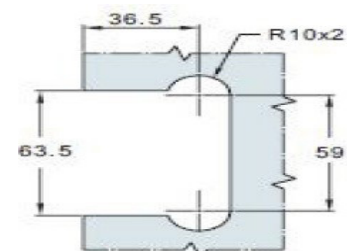
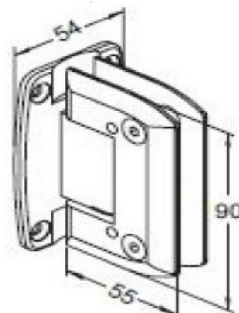

## ZUHANYPÁNTOK

**AH703G 180° Üveg-üveg, állítható rugós pánt, szálcsiszolt, polír (36kg/2pánt) 8-10 mm-es üveghez**

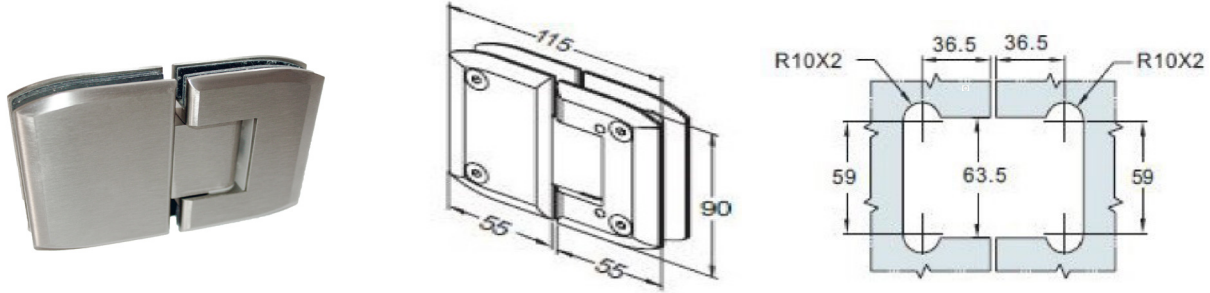

**AH704G 90° Üveg-üveg, állítható rugós pánt, szálcsiszolt, polír (36kg/2pánt) 8-10 mm-es üveghez**

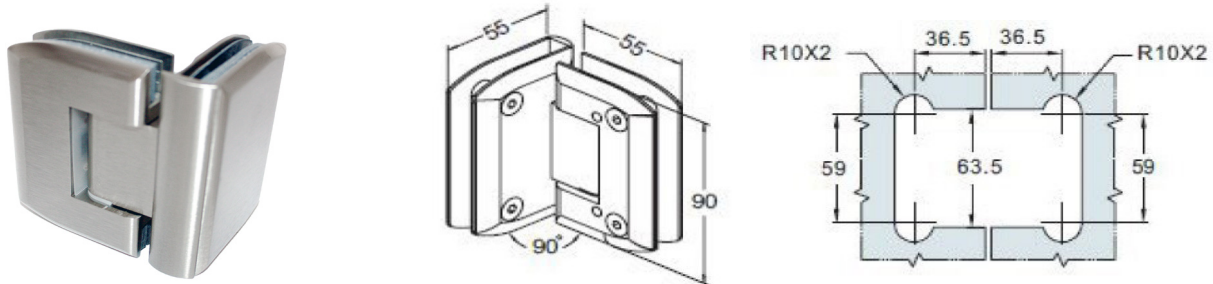

**AH705G 135° Üveg-üveg, állítható rugós pánt, szálcsiszolt, polír (36kg/2pánt) 8-10 mm-es üveghez**

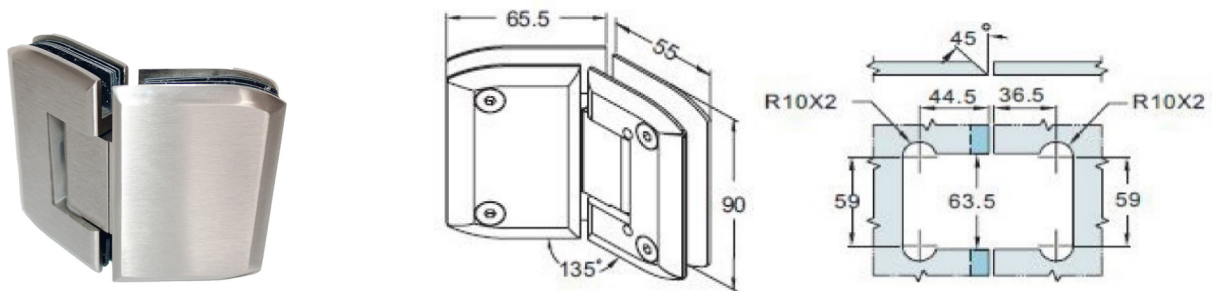

**AH700S Aszimmetrikus, állítható rugós pánt, szálcsiszolt, polír (36kg/2pánt) 8-10 mm-es üveghez**

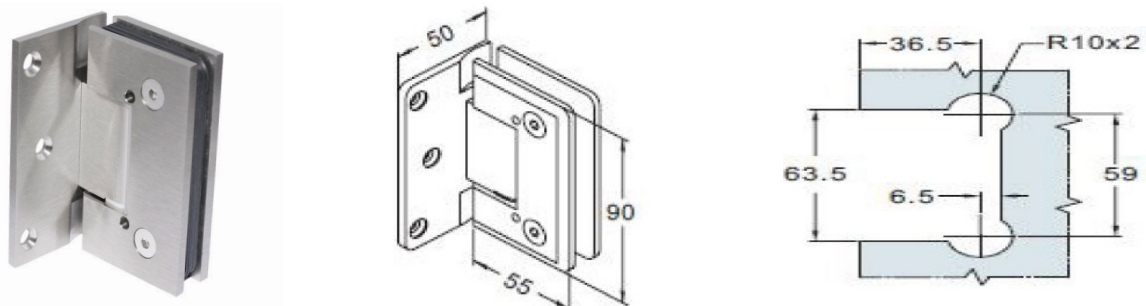

**AH701S Szimmetrikus, állítható rugós pánt, szálcsiszolt, polír (36kg/2pánt) 8-10 mm-es üveghez**

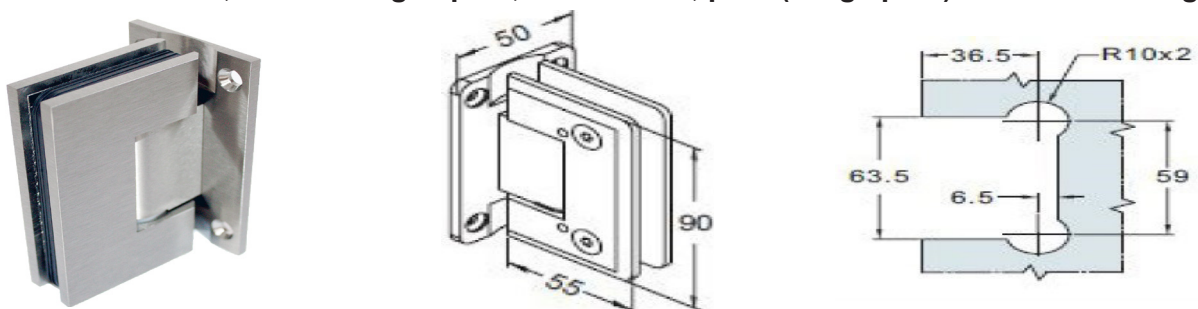

## ZUHANYPÁNTOK

**AH703S 180° Üveg-üveg, állítható rugós pánt, szálcsiszolt, polír (36kg/2pánt) 8-10 mm-es üveghez**

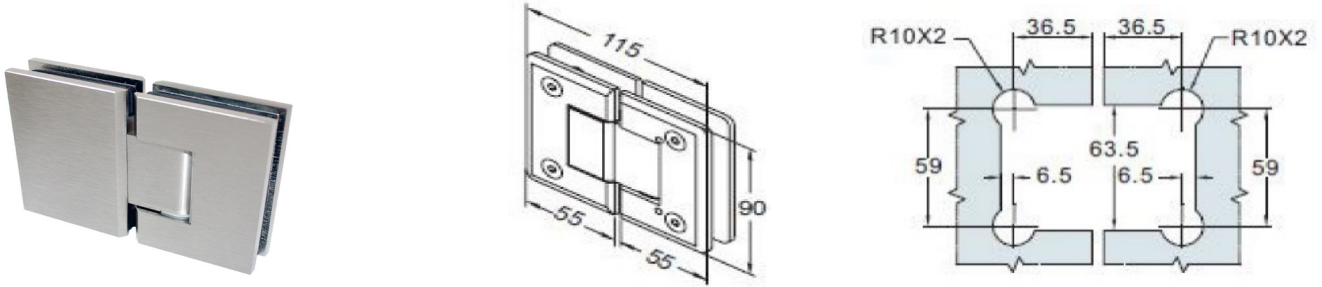

**AH704S 90° Üveg-üveg, állítható rugós pánt, szálcsiszolt, polír (36kg/2pánt) 8-10 mm-es üveghez**

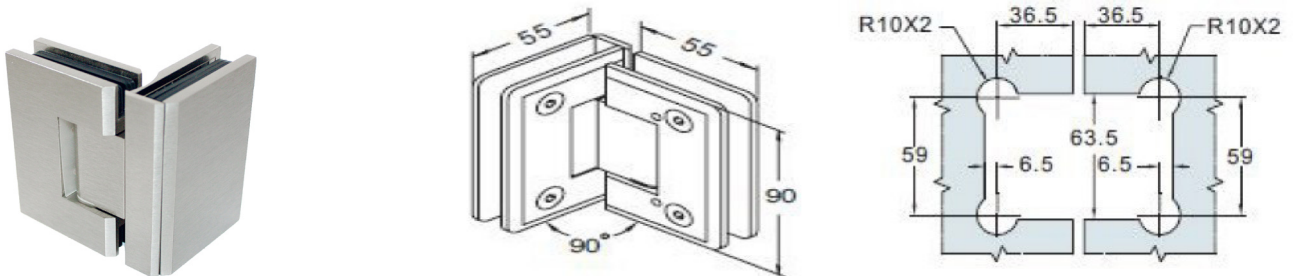

**AH705S 135° Üveg-üveg állítható rugós pánt, szálcsiszolt, polír (36kg/2pánt) 8-10 mm-es üveghez**

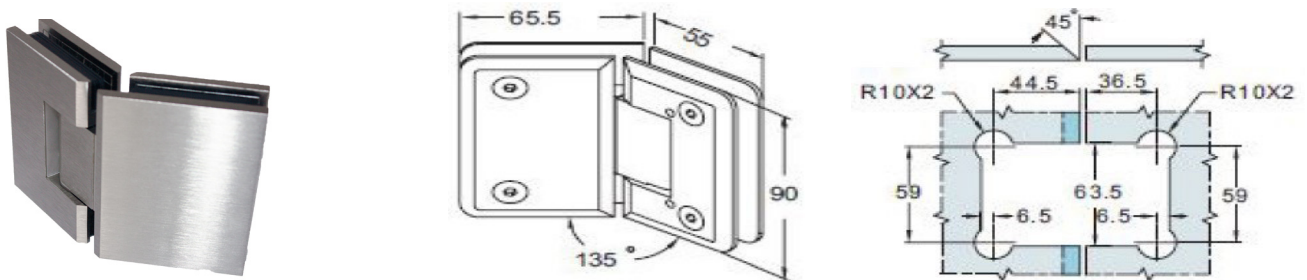

**SH700C Aszimmetrikus rugós pánt, szálcsiszolt, polír (36kg/2pánt) 8-10 mm-es üveghez**

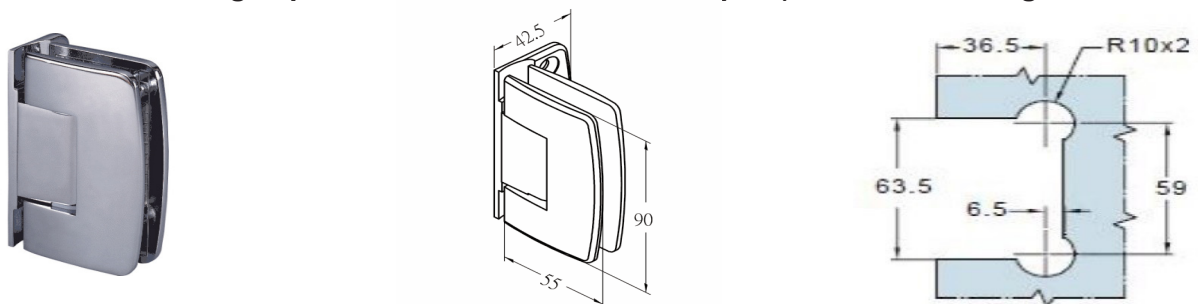

**SH703C 180° Üveg-üveg rugós pánt, szálcsiszolt. polír (36kg/2pánt) 8-10 mm-es üveghez**

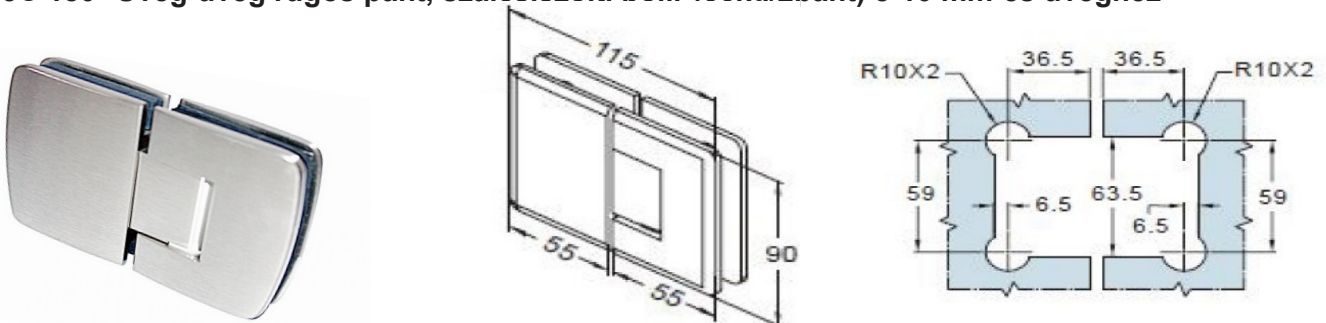

## AJTÓGOMBOK

Mágneses rögzítő, szauna ajtóhoz

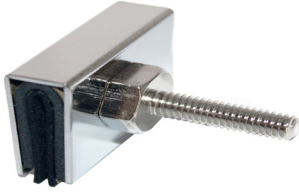

Csak 8mm-es üveghez,  
Polírozott kivitelben

Fagomb

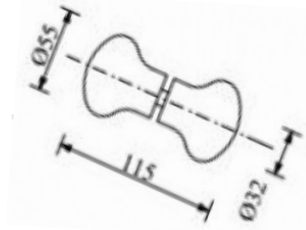

KN301 szálcsiszolt, polír

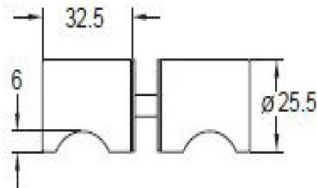

KN303 szálcsiszolt, polír

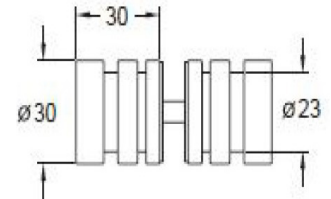

KN304 szálcsiszolt, polír

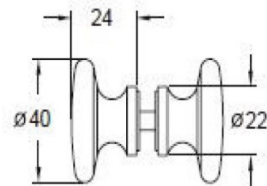

KN315 szálcsiszolt, polír

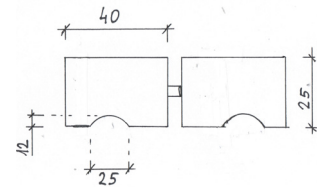
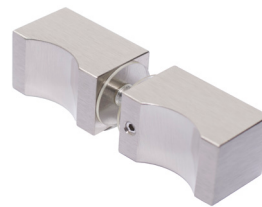

KN307 szálcsiszolt, polír

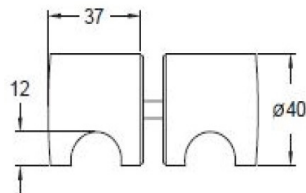

KN308 szálcsiszolt, polír

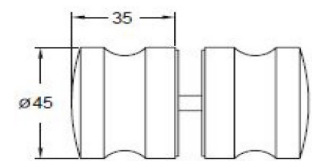

## ÜVEGBÚTOR SZERELVÉNYEK - POLCTARTÓK

Rozsdamentes szálcsiszolt, ill. polírozott kivitelben.

ÜV1

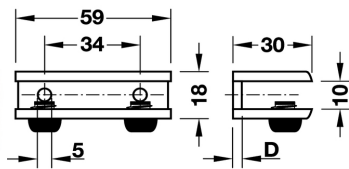

ÜV3

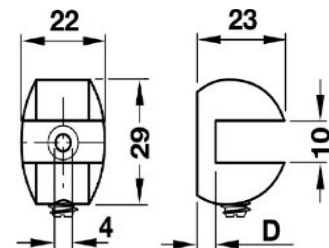

ÜV5

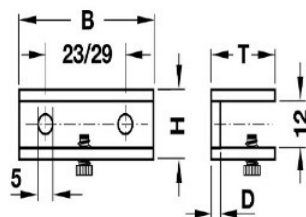

ÜV8

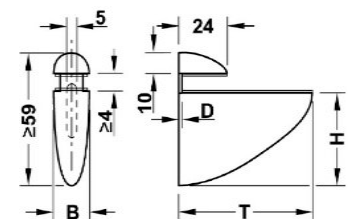

## MEREVÍTŐ SZERELVÉNYEK

**SB045** Indító, szálcsiszolt, polír

**SS045**

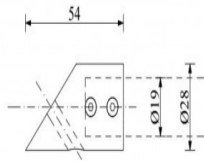

**SB008** Állítható rúd összekötő csipesszel, szálcsiszolt, polír



**SB001** Fali indító, szálcsiszolt, polír

**SS001**

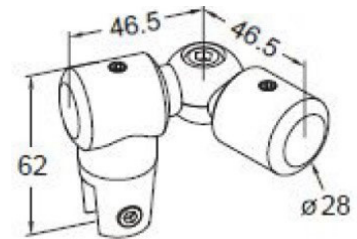
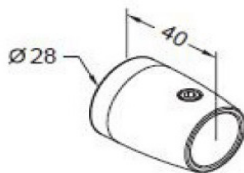

**SB003** Átmenő furatos csipesz, szálcsiszolt, polír **SS003**



**SBT T** Idom, szálcsiszolt, polír

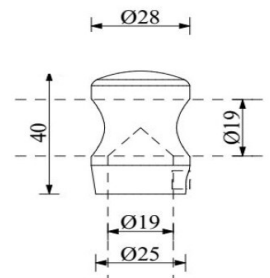

**SB004** Végzáró csipesz, szálcsiszolt, polír **SS004**

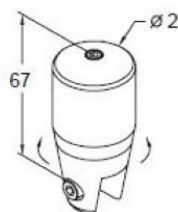

**SB007** Állítható rúdösszekötő, szálcsiszolt, polír



**SB011** 19 mm átmérőjű cső, **SS011** 19x19 mm zártszelvény, 2000 mm hosszban, szálcsiszolt, polír

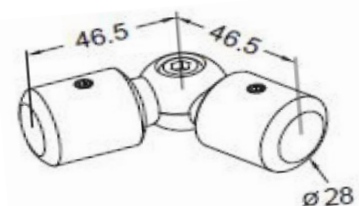
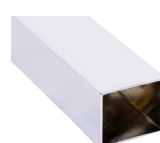
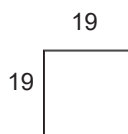
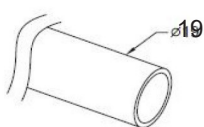



## FIX MEGFOGÓK

**GC507S 90° Talpas, fal-üveg, fix megfogó, dupla, szálcsiszolt, polír**

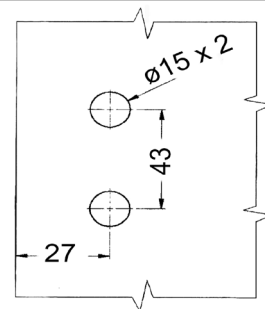
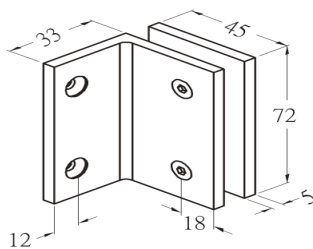

**GC701G Fal-üveg, fix megfogó, szálcsiszolt, polír**

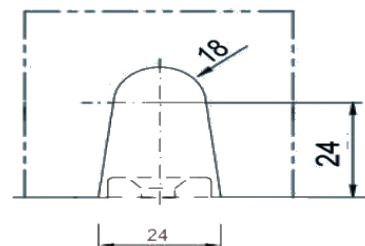
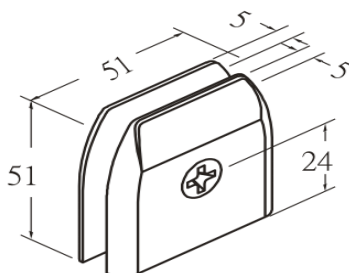

**GC704G 90° Üveg-üveg, fix megfogó, szálcsiszolt, polír**

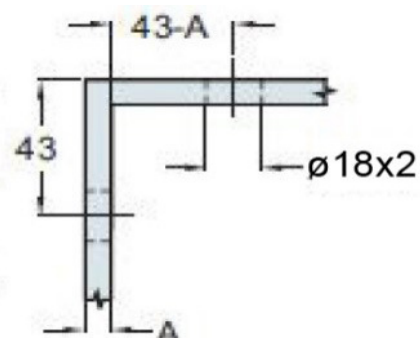
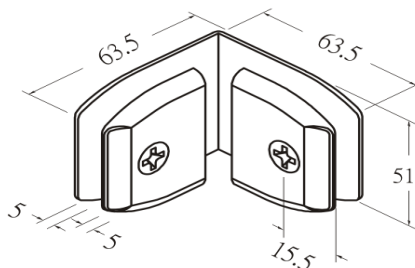

**GC705G 135° Üveg-üveg, fix megfogó, szálcsiszolt, polír**

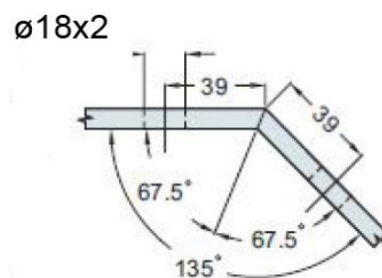
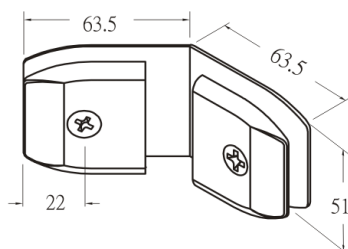

**GC706G 90° Talpas, fal-üveg, fix megfogó, szálcsiszolt, polír**

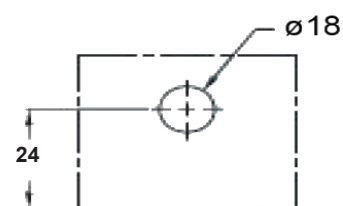
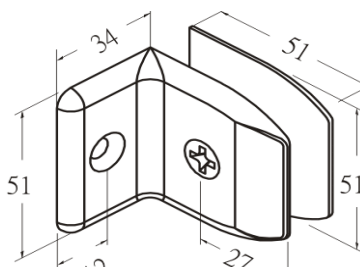

## FIX MEGFOGÓK

GC701S 90° Fal-üveg, fix megfogó, szálcsiszolt, polír

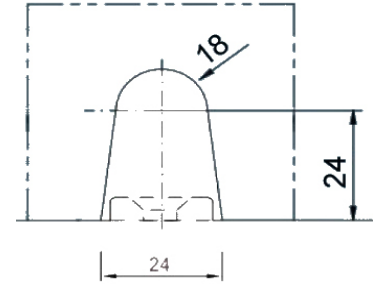
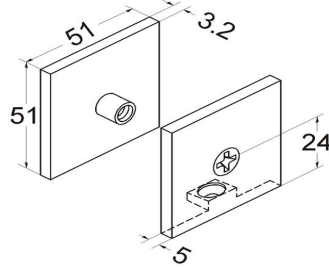
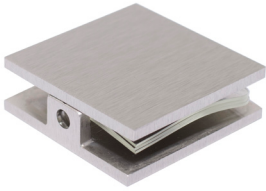

GC704S 90° Üveg-üveg, fix megfogó, szálcsiszolt, polír

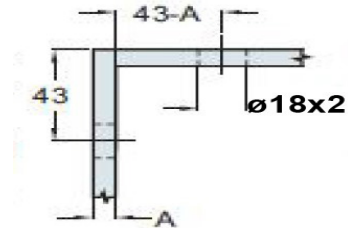
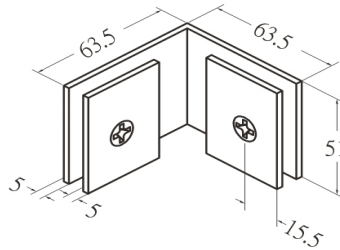

GC705S 135° Üveg-üveg, fix megfogó, szálcsiszolt, polír

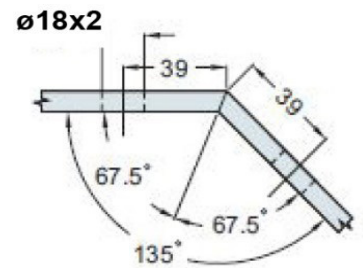
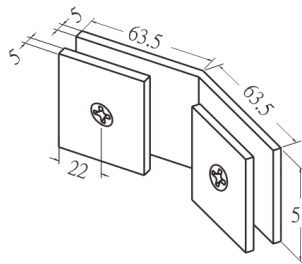

GC706S 90° Fal-üveg, fix megfogó, szálcsiszolt, polír

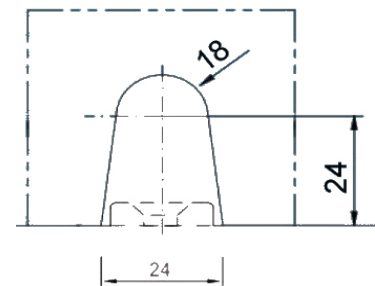
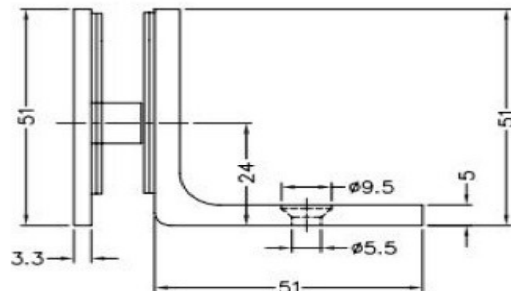

GC801C Fal-üveg, fix megfogó, szálcsiszolt, polír

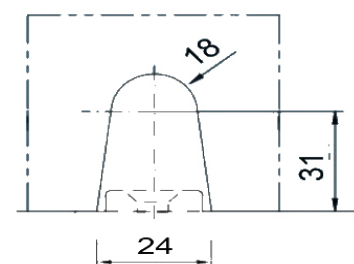
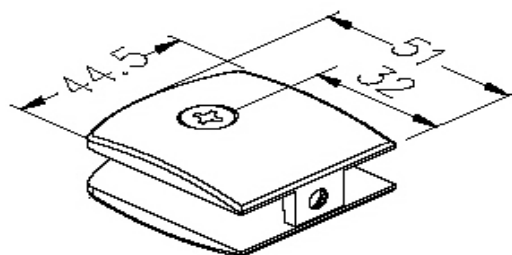

## FIX MEGFOGÓK

**GC804C 90° Üveg-üveg, fix megfogó, szálcsiszolt, polír**

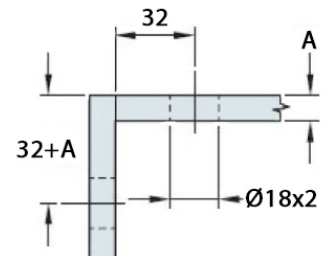
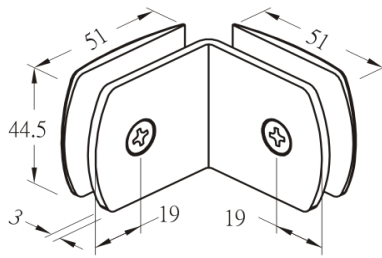

**GC806C 180° Talpas, fal-üveg, fix megfogó, szálcsiszolt, polír**

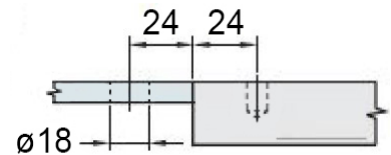
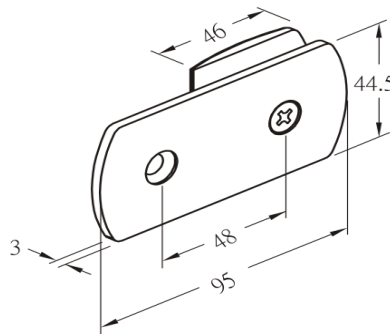
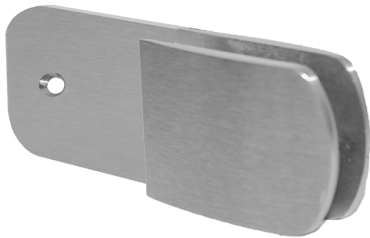

**GC807C 90° Talpas, fal-üveg, fix megfogó, szálcsiszolt, polír**

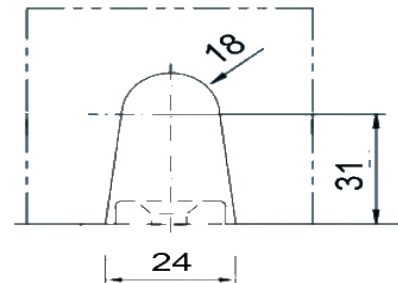
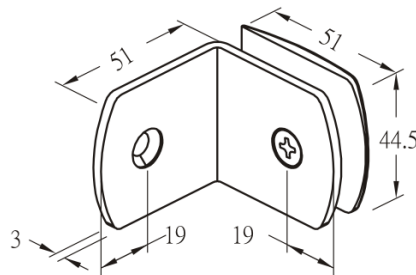

**GC703G 180°-os üveg-üveg, fix megfogó, szálcsiszolt, polír**

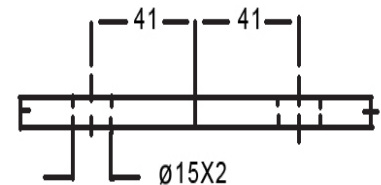
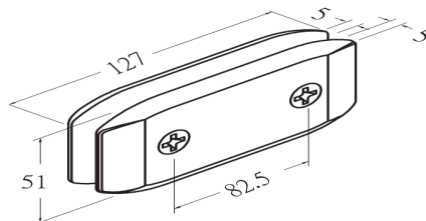

**GC703S 180°-os üveg-üveg, fix megfogó, szálcsiszolt, polír**

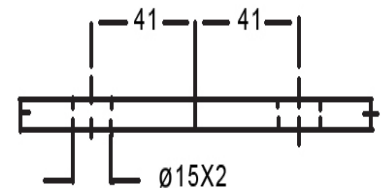
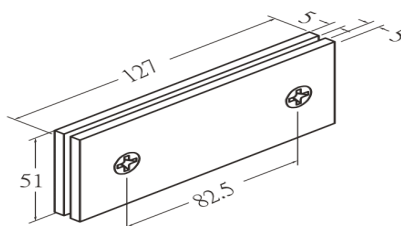

## VÍZZÁRÓ PROFILOK

WS107 h - profil	D - profil	Üvegvastagság										
		6-os	8-as	10-es	Levonás az üvegből							
		h 8-as szakáll	2,2 m	2,2-2,5 m	2,5 m	8 mm						
		h 16-os szakáll	X	2,2-2,5 m	X	16 mm						
		D Profil	2,2 m	2,2-2,5 m	2,5 m	8 mm						
		Fali mágnes	X	2,2-2,5 m	X	17 mm						
		Mágnes 90 fok	2,2 m	2,2-2,5 m	2,5 m	12-12 mm						
		Mágnes 135 fok	X	2,2 m	X	12-12 mm						
		Mágnes 180 fok	2,2 m	2,2-2,5m	2,5 m	12-12 mm						
		F Profil	X	2,5 m	X	0 mm						
		Alsó vízzáró	2,2 m	2,2 m	2,2 m	12 mm						
		Alsó vízzáró dupla szakállas	X	2,2 m	X	10 mm						
		Kültéri h	X	3 m	3 m	X						
		Kültéri H	X	3 m	3 m	X						
		Kültéri D	X	4 m	X	X						
		Kültéri dupla F	X	2,5 m	X	X						
		<b>MS90 90° Mágneses vízzáró profil</b>										
		<b>Kültéri H profil</b>										
		<b>Kültéri dupla F profil</b>										
		<b>MS135 135° Mágneses vízzáró profil</b>										
		<b>Kültéri h profil</b>										
		<b>MS180 180° Mágneses vízzáró profil</b>										
		<b>Kültéri D profil</b>										
		<b>5-10mm Vízkifolyást gátló akril küszöb</b>										
						<table border="1"> <thead> <tr> <th>Méret</th> <th>Profil hossz</th> </tr> </thead> <tbody> <tr> <td>5x10mm</td> <td>2000mm</td> </tr> <tr> <td>10x20mm</td> <td>2000mm</td> </tr> </tbody> </table>	Méret	Profil hossz	5x10mm	2000mm	10x20mm	2000mm
Méret	Profil hossz											
5x10mm	2000mm											
10x20mm	2000mm											

# PONTMEGFOGÓ SZERELVÉNYEK

## PONT- ÉS KORLÁTMEGFOGÓK

SF13812AF Átmenőfuratos, állítható pontmegfogó, szálcsiszolt

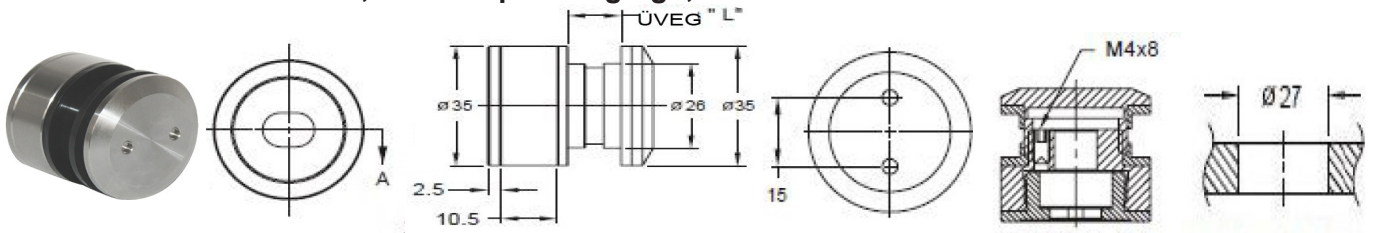

SF0010 Átmenőfuratos pontmegfogó fej, szálcsiszolt

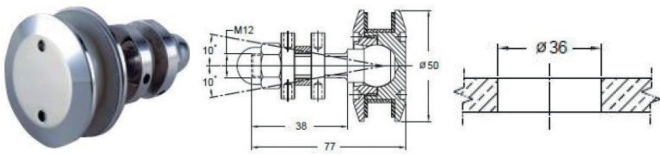

CAP50 Átmenőfuratos, menetes pontmegfogó, kérésre egyedi távtartóval, szálcsiszolt

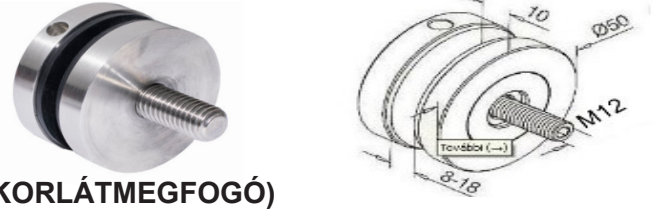

CAP30 Átmenőfuratos, menetes pontmegfogó, menetes távtartóval, szálcsiszolt



BC056 Pontmegfogó, furat nélkül, szálcsiszolt 6-12 mm-es üveghez

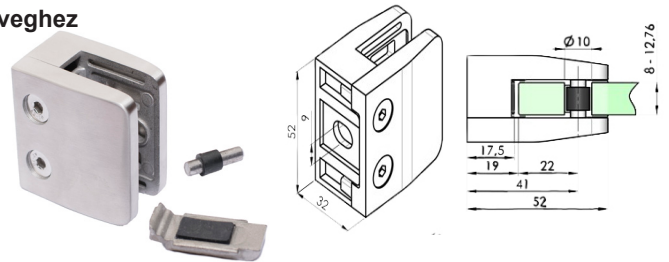

BC045 Pontmegfogó, furat nélkül, szálcsiszolt 6-10 mm-es üveghez

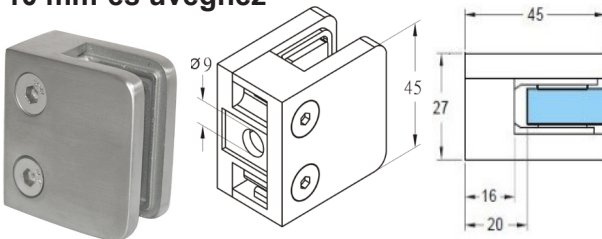

BC050 Pontmegfogó, furat nélkül, szálcsiszolt 6-10 mm-es üveghez

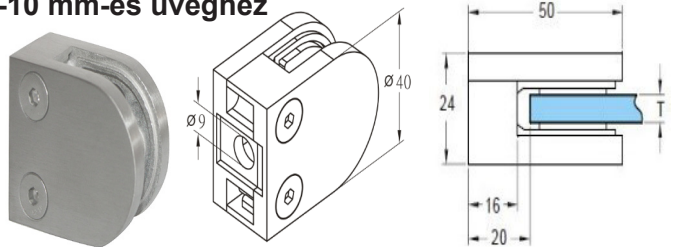

GC03075F Fal-üveg, csuklós pontmegfogó, szálcsiszolt

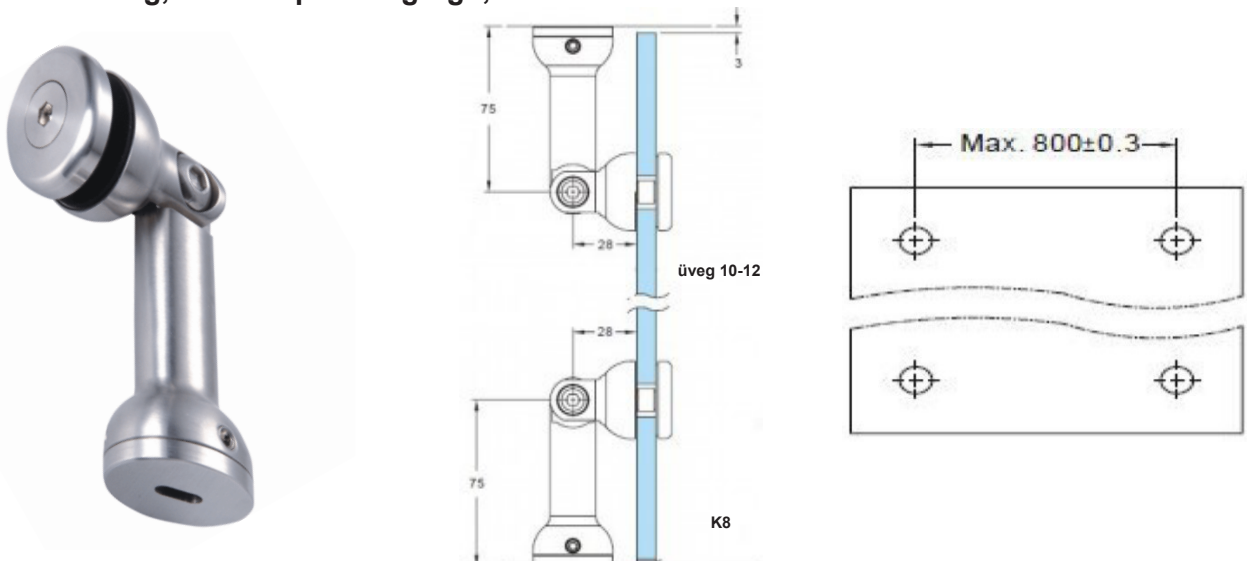

# PONTMEGFOGÓ ÉS ELŐTETŐ SZERELVÉNYEK

## PONTMEGFOGÓK

Alsólábás korlátmegfogás, rozsdamentes szálcsiszolt 6.6.2 és 8.8.2 üveghez

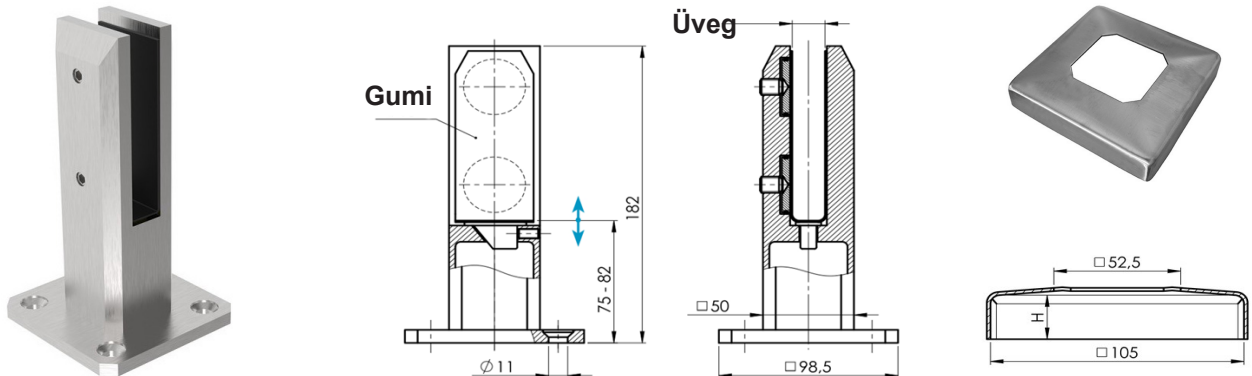

Függesztett, pontmegfogásos előtető szerelvény.  
 A ház falához, a födémben, majd a rögzítő rúd által a falhoz rögzítve, szálcsiszolt kivitelben.  
 Csak szettben elérhető.



Fal - Üveg Konzol



Rúd - Üveg Konzol



Fal - Rúd Konzol

## T 45, DOMESTIC TOLÓAJTÓK, KIEGÉSZÍTŐK

T-45, 45kg oldalfali, csillapítós.

45kg teherbírású, oldalfali szerelhetőségű, kétoldali csillapítóval, alsó vezetővel ellátott, keret nélküli, edzett üveg tolóajtó szerkezet. Eloxált alumínium kivitelben. Kizárólag 8 mm-es üveghez!

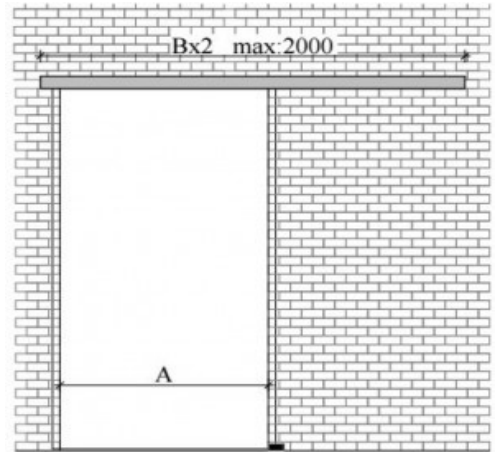
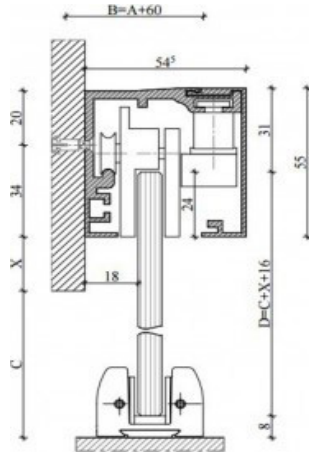

Domestic 80kg teherbírású, mennyezeti szerelhetőségű, oldalvilágítóval is alkalmazható, alsó vezetővel ellátott, keret nélküli, edzett üveg tolóajtó szerkezet. Eloxált alumínium kivitelben. 8-10 mm-es üveghez!

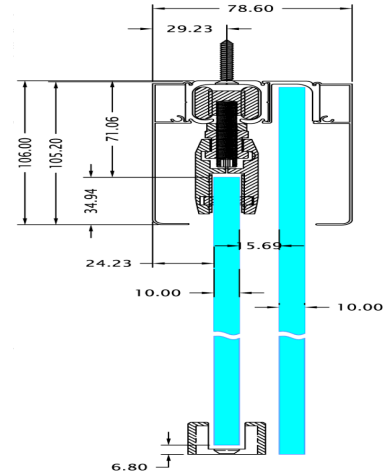
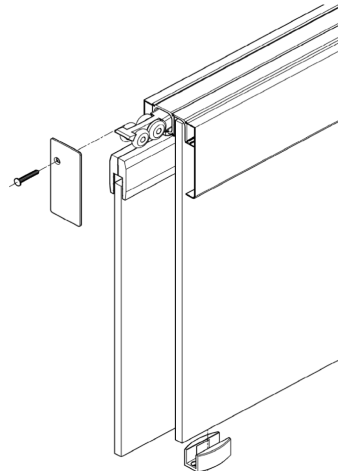

Minden üvegtípusra (8-12 mm), méretre, vastagságra forgalmazunk keretnélküli üveg tolóajtókat. A szerkezetek tartalmazhatnak egy- vagy kétoldali csillapítást, szinkron nyitás is megoldható. Extra teherbírású, akár 200 kg-mal terhelhető sínekkel is dolgozunk. Vontatós kialakításra is van lehetőség.

SDK02 Húzógyűrű, furat az üvegen 55mm, szálciszolt, 8 és 10 mm üveghez is.

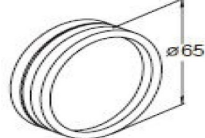

SD601 Kampós zár ellendarab, szálciszolt

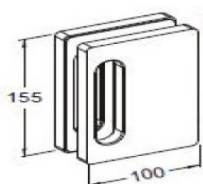

SD600 Kampós zár, szálciszolt

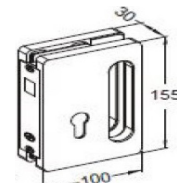

SD500 Alsó-vezető, szálciszolt

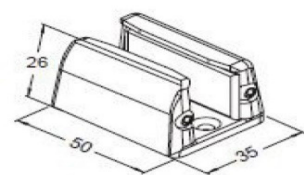

# KORLÁT SZERELVÉNYEK

## ALSÓ VONALMENTI, SINES KORLÁTOK FÖDÉMRE

Alsó sínes vonalmenti korlát megfogás, földémre szerelhető, eloxált alumínium (AL), rozsdamentes színre eloxálva is (AR)

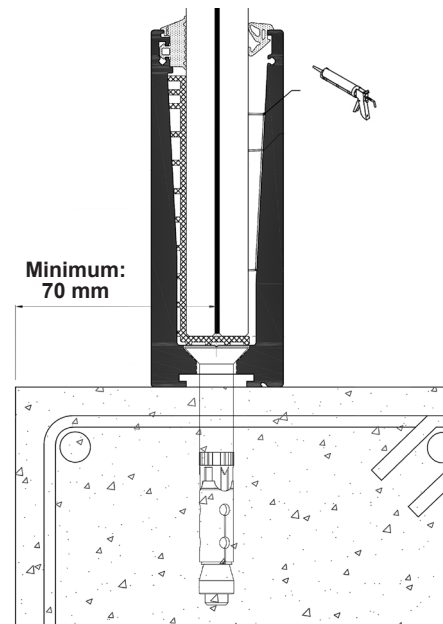
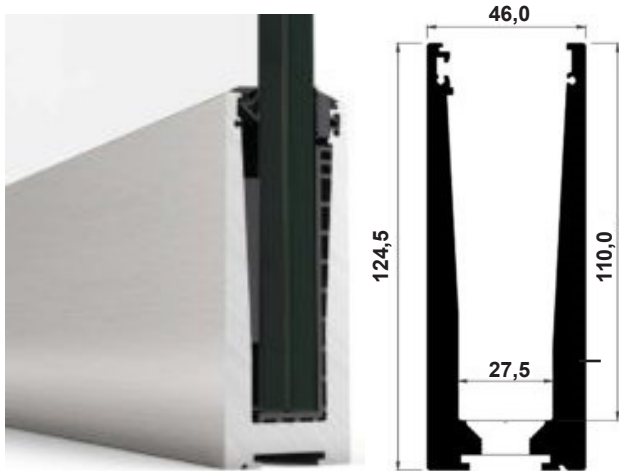

Név	Alkalmazható	Hossz
BC125-1KN-AL	6+6, 8+8, 10+10mm	6000mm
BC125-1KN-AR	6+6, 8+8, 10+10mm	6000mm



Víz kifolyató profil, alsó vonalmenti sínhez, eloxált alumínium kivitelben



BC125LF eloxált alumínium (AL), rozsdamentes színre eloxálva (AR)

Alsó sínes vonalmenti korlát megfogás, földém szélére szerelhető, eloxált alumínium (AL), rozsdamentes színre eloxálva is (AR)

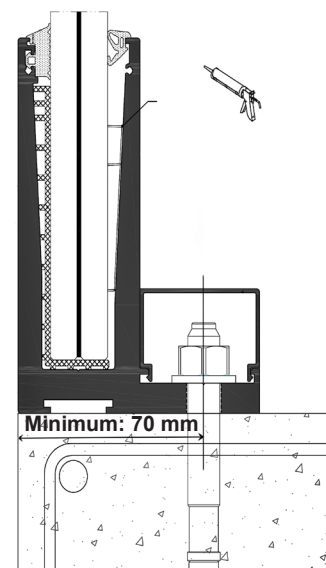
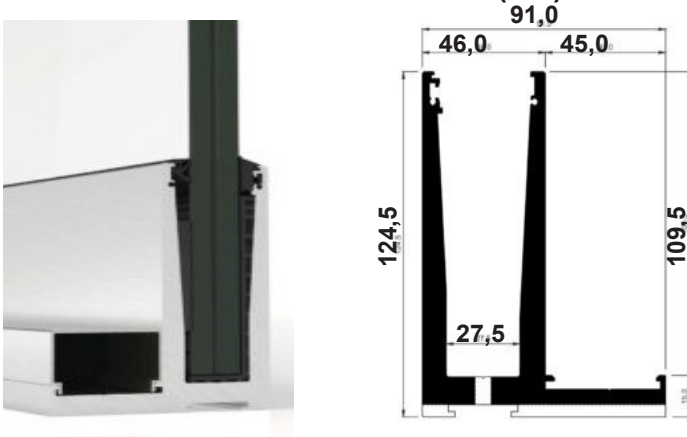

Név	Alkalmazható	Hossz
BC125L-3KN-AL	6+6, 8+8, 10+10mm	6000mm
BC125L-3KN-AR	6+6, 8+8, 10+10mm	6000mm



# KORLÁT SZERELVÉNYEK

## ALSÓ VONALMENTI, SINES KORLÁTOK FÖDÉM OLDALÁRA

Alsó sínes vonalmenti korlát megfogás, földém oldalára szerelhető eloxált alminium (AL), rozsdamentes színre eloxálva is (AR)

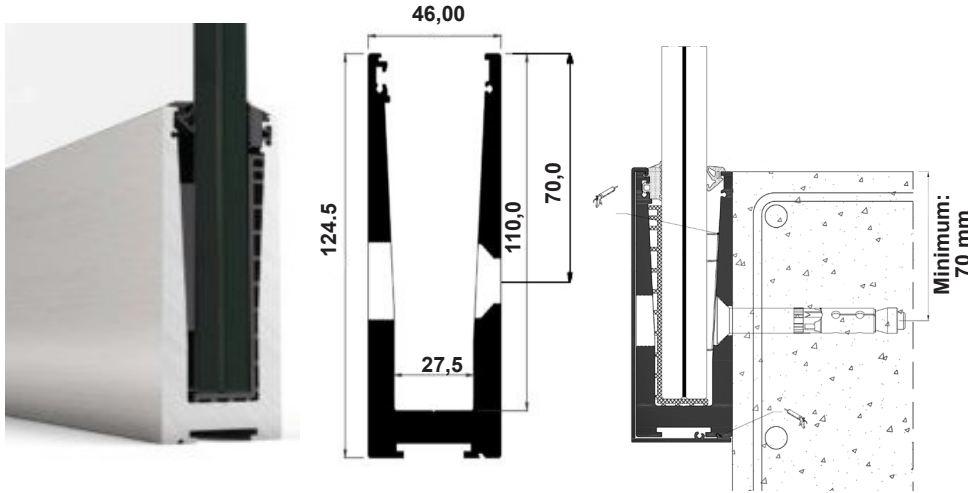

**BC125WF**  
eloxált alminium (AL),  
rozsdamentes színre  
eloxálva (AR)

Földém oldalára szerelhető  
sínre való fedél.



Név	Alkalmazható	Hossz
BC125W-3KN-AL/AR	6+6, 8+8, 10+10mm	6000mm

Alsó sínes vonalmenti korlát megfogás, szigetelt földém oldalára szerelhető eloxált alumínium (AL), rozsdamentes színre eloxált fedéllel is (AR)

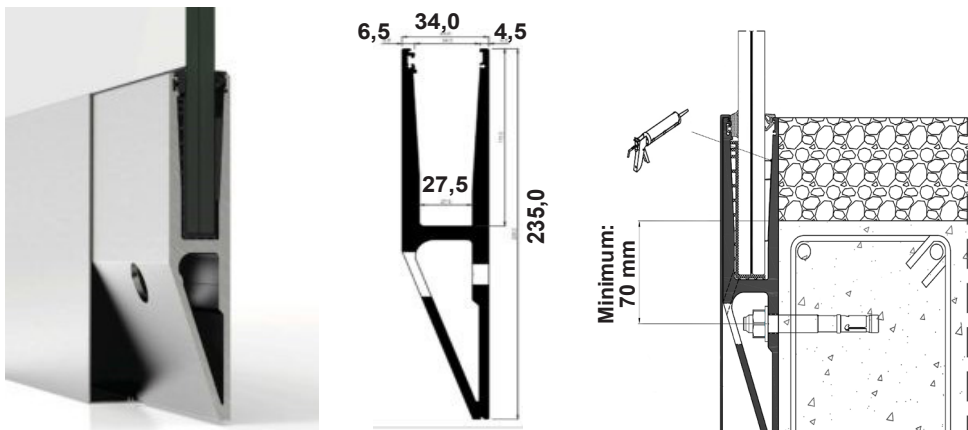

**BC125WF**  
eloxált alminium (AL),  
rozsdamentes színre  
eloxálva (AR)

Földém Oldalára Szerel-  
hető Sínrre való fedél.



Név	Alkalmazható	Hossz
BC235W-3KN-AL/AR	6+6, 8+8, 10+10mm	6000mm

### U PROFIL KAPASZKODÓK

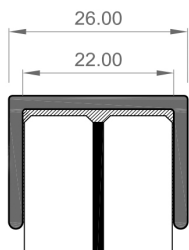

10+10 mm-es  
üveghez  
eloxált alumini-  
um,  
rozsdamentes  
színre eloxált

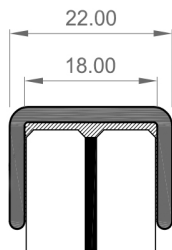

8+8 mm-es  
üveghez  
eloxált alumini-  
um,  
rozsdamentes  
színre eloxált

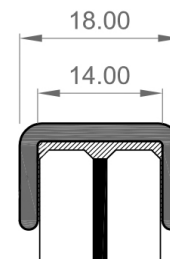

6+6 mm-es  
üveghez  
eloxált alumini-  
um,  
rozsdamentes  
színre eloxált

# BALKON-VILÁG, LAPOZHATÓ ÜVEGFALRENDSZER

## BALKON-VILÁG



Lapozható üvegfal rendszer, 8mm ESG biztonsági üveggel, felső megvezetéssel, alsó-felső terheléssel, nyíló, zárható ajtó lehetőséggel, üvegtáblák közt akril tömítéssel. Eloxált alumínium ill. fehér porfestett kivitelben.

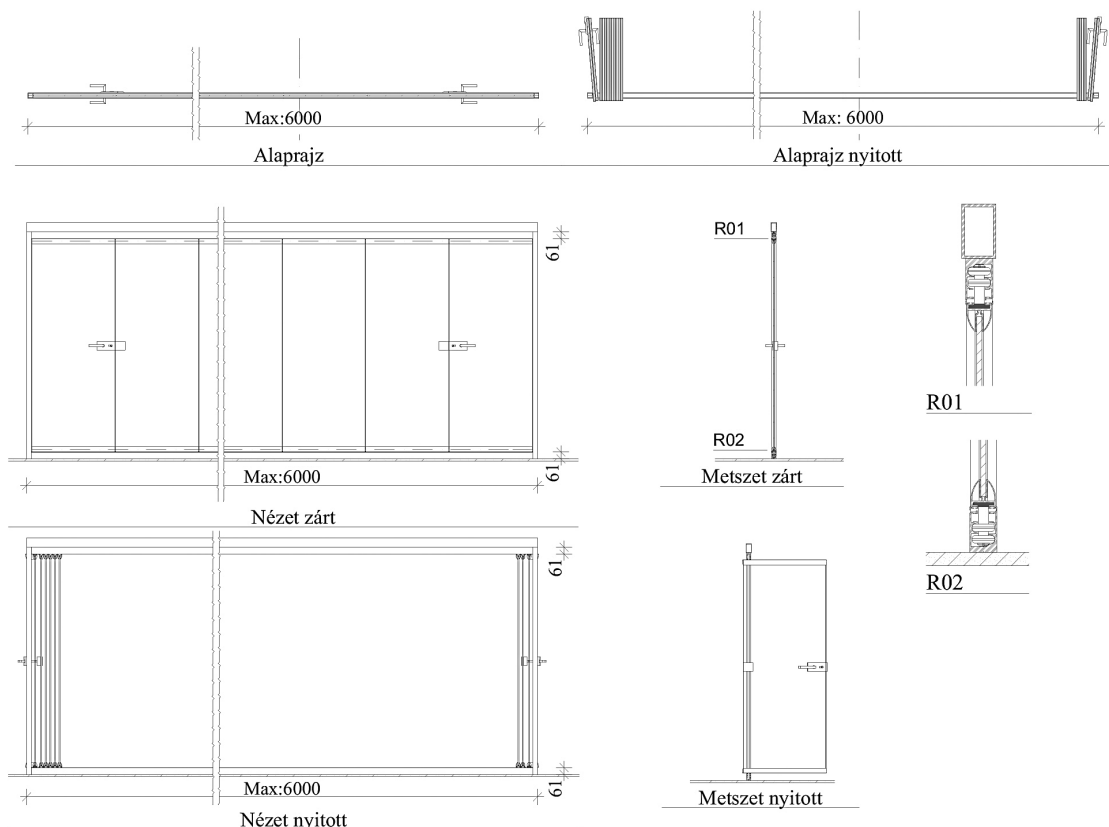

# BALKON-VILÁG, LAPOZHATÓ ÜVEGFALRENDSZER

## BALKON-VILÁG PLUSZ



Egymás mellé tolható üvegfalrendszer, 8-10mm ESG biztonsági üveggel, felső megvezetéssel, alsó terheléssel. Eloxált alumínium kivitelben.

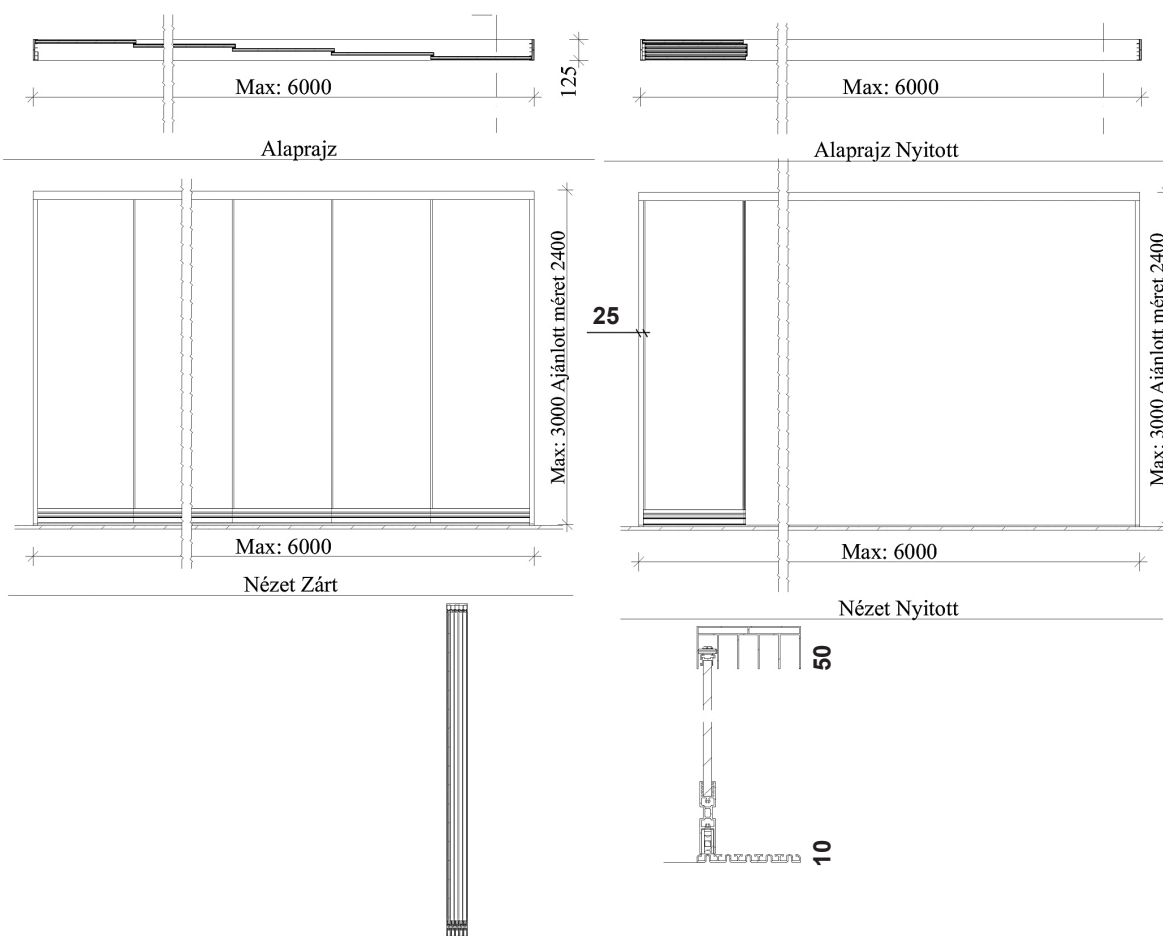



“Üveg és a körülötte lévő világ”



**EDZETT, LAMINÁLT, DEKOR ÜVEG RÖVID HATÁRIDŐVEL  
FOUR GLASS EDZÉSJELLEL ELLÁTVA**



Üvegajtók



Zuhanykabinok



Edzett üveg szerelvények



Télikert üvegfal rendszerek



Üvegbeépítések



Üveg korlátok



Portálüvegek

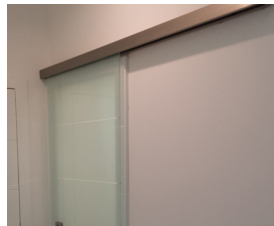

Tolóajtók



Konyhahátfalak

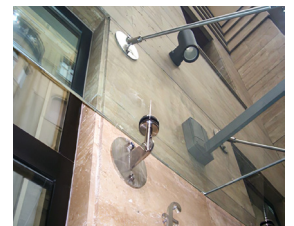

Előtető szerkezetek



Járható üvegek



Jármű üvegek



Üvegbútorok



Üvegszállító kocsik

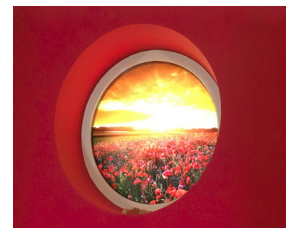

Dekorüvegek



5900 Orosháza Szület utca 14.  
[www.uvegvilag.hu](http://www.uvegvilag.hu)  
[info@uvegvilag.hu](mailto:info@uvegvilag.hu)

Nyitvatartási idő  
Hétköznap  
8:00 - 16:00

Tel, Fax: 06-68/418-475  
Mobil: 06-70/381-06-74  
06-20/465-77-55